

KENWOOD

AUDIO VIDEO SURROUND RECEIVER

KR-V990D

INSTRUCTION MANUAL

KENWOOD CORPORATION

Getting started

Caution: Read this page carefully to ensure safe operation.

KR-V9900 (En)

Before applying the power

Units are designed for operation as follows.

U.S.A. and Canada AC 120 V only
Australia AC 240 V only

China AC 220 V only
*Other countries AC 110-120 / 220 / 230-240 V switchable

* AC voltage selection

The AC voltage selector switch on the rear panel is set to the voltage that prevails in the area to which the unit is shipped. Before connecting the power cord to your AC outlet, make sure that the setting position of this switch matches your line voltage. If not, it must be set to your voltage in accordance with the following direction.

Note:
Our warranty does not cover damage caused by excessive line voltage due to improper setting of the AC voltage selector switch.

AC voltage selector switch

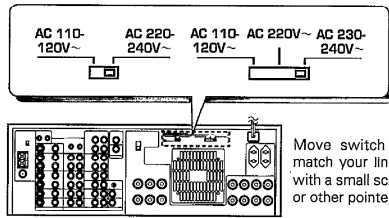

Safety precautions

WARNING : TO PREVENT FIRE OR ELECTRIC SHOCK, DO NOT EXPOSE THIS APPLIANCE TO RAIN OR MOISTURE.

	CAUTION RISK OF ELECTRIC SHOCK DO NOT OPEN		CAUTION: TO REDUCE THE RISK OF ELECTRIC SHOCK, DO NOT REMOVE COVER (OR BACK). NO USER-SERVICEABLE PARTS INSIDE, REFER SERVICING TO QUALIFIED SERVICE PERSONNEL.
	THE LIGHTNING FLASH WITH ARROWHEAD SYMBOL, WITHIN AN EQUILATERAL TRIANGLE, IS INTENDED TO ALERT THE USER TO THE PRESENCE OF UNINSULATED "DANGEROUS VOLTAGE" WITHIN THE PRODUCT'S ENCLOSURE THAT MAY BE OF SUFFICIENT MAGNITUDE TO CONSTITUTE A RISK OF ELECTRIC SHOCK TO PERSONS.		
	THE EXCLAMATION POINT WITHIN AN EQUILATERAL TRIANGLE IS INTENDED TO ALERT THE USER TO THE PRESENCE OF IMPORTANT OPERATING AND MAINTENANCE (SERVICING) INSTRUCTIONS IN THE LITERATURE ACCOMPANYING THE APPLIANCE.		

Unpacking

Unpack the unit carefully and make sure that all accessories are put aside so they will not be lost. Examine the unit for any possibility of shipping damage. If your unit is damaged or fails to operate, notify your dealer immediately. If your unit was shipped to you directly, notify the shipping company without delay. Only the consignee (the person or company receiving the unit) can file a claim against the carrier for shipping damage. We recommend that you retain the original carton and packing materials for use should you transport or ship the unit in the future.

Accessories

FM indoor antenna (1)



AM loop antenna (1)



Loop antenna stand (1)

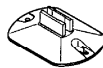

Remote control unit (1)



Batteries(R6/AA) (2)



Repeater (1)



Double-sided tape (1)





*AC plug adaptor (1)



* Use to adapt the power cord to the shape of the wall outlet. (Accessory only for regions where use is necessary.)

Contents

Caution : Read the pages marked  carefully to ensure safe operation.

Getting started	2
 Before applying the power	2
 Safety precautions	2
Unpacking	2
Special features	4
Names and functions of parts	5
System connections	6
Connecting the antennas	6
FM DE-EMPHASIS/CHANNEL SPACE switch	6
Connecting audio components	7
Connecting video components	8
Connecting the system control	9
Connecting the speakers	10
Connecting the repeater	11
How to use the remote control	12
Names and functions of keys	12
Operations	13
Using the OSD (On Screen Display)	14
Switching to GUI (Graphical User Interface) mode	14
Operating in GUI mode	15
Preparing for playback (SET UP)	17
System set up	17
Surround set up	20
Normal playback	22
Listening to source components	22
Adjusting the sound	23
Recording	25
Recording audio	25
Recording video	26
Listening to radio broadcasts	27
Tuning radio stations	27
Tuning radio stations by frequency (DIRECT tuning)	28
Presetting radio stations	29
Receiving preset stations	29
Receiving preset stations in order (P.CALL)	29
Ambience effects	30
Sound modes	30
Playing back with surround sound	32
Remote controlling video components	34
How to operate video components	34
Set up code chart	35
OSD flow chart	39
In case of difficulty	41
 Specifications	43

Special features

A variety of home theater functions

This receiver is provided with a variety of surround modes to bring you maximum enjoyment from your video software. Select a surround mode according to your equipment or the software you are going to play. Enjoy!

- [20] - [30]

DOLBY AC-3

The Dolby AC-3 mode lets you enjoy LD software marked **DOLBY SURROUND** AC-3 DIGITAL, as well as the input of other Dolby AC-3 format digital signals, in digital surround. By providing up to 5.1 channels of digital audio independently, Dolby AC-3 lets you to enjoy better sound quality and more powerful presence than conventional Dolby Surround.

DOLBY PRO LOGIC & DOLBY 3 STEREO

This surround system reproduces theater-like surround sound from video software marked **DOLBY SURROUND**. The DOLBY PRO LOGIC mode uses the built-in directivity enhancer circuit to control the Left, Center, Right and Surround channel audio signals and reproduce a real sense of sound motion.

The DOLBY 3 STEREO mode uses the directivity enhancer circuit to provide proper acoustic positioning and a real sense of sound motion even when only the front and center speakers are used.

DSP LOGIC

This mode uses DSP (Digital Signal Processor) to add an element of "presence" to the DOLBY PRO LOGIC signals (Left, Center, Right and Surround) output from the directivity enhancer circuit, and bring the extra sense of dimensionality, associated with movie theaters, to your listening room.

Simple home theater operation

Easy operation with OSD (On Screen Display)

This function uses a monitor TV to simplify the previously difficult setup procedures like, surround setup, remote control setup code input, and macro-play setup. Once you've completed these setups, all you have to do is enjoy your movies.

You can also use OSD for basic operation of source components. Connecting KENWOOD source components with the System Control (SL16 only), lets you use OSD to display information about the current source.

- [14]

IR (Infrared Ray) remote control

To watch video software, you used to have to use the infrared ray remote control supplied with your monitor TV and video equipment. This receiver, however, is supplied with a repeater that lets you turn ON and start playback from your video components once you specify the remote control setup code. Be sure to set up the IR remote before you start watching movies.

- [11] - [18] - [34]

MACRO PLAY

This function lets you perform a series of operations automatically with the push of a single button.

Once you store the steps necessary to perform a specific operation, like starting playback from your LD player or video deck, you can perform those operations, like turning ON the power, switching the inputs, and starting playback, automatically. (To operate video equipment in a macro play, be sure to input the remote control setup code before starting the macro set up procedure.)

- [18]

Names and functions of parts

KR-V950D (En)

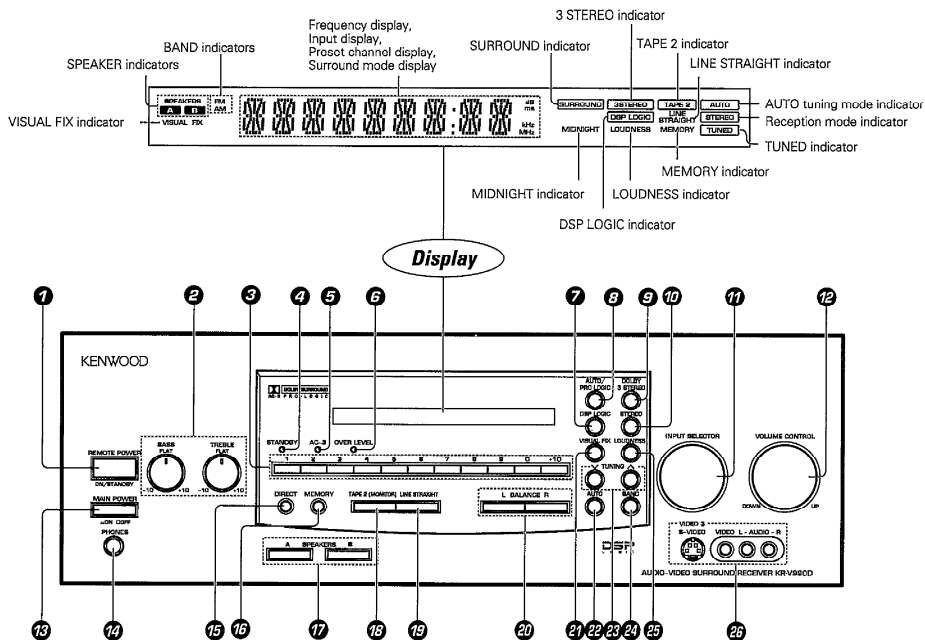

- ❶ **REMOTE POWER key**
Use to switch the power ON/STANDBY when the MAIN POWER is turned ON.
- ❷ **Tone Control knobs** - [23]
② **Numeric keys**
④ **STANDBY indicator**
⑤ **AC-3 indicator**
Lights when an AC-3 format signal is being played back.
- ⑥ **OVER LEVEL indicator** - [21]
Lights when the level of the signal being input is too high.
- ⑦ **DSP LOGIC key** - [32]
Use to turn on, or switch, the DSP LOGIC mode.
- ⑧ **AUTO/PRO LOGIC key** - [22]
Use to turn on, or switch, the DOLBY SURROUND mode.
- ⑨ **DOLBY 3 STEREO key** - [32]
Use to turn on the DOLBY 3 STEREO mode.
- ⑩ **STEREO key** - [32]
Use to cancel the surround mode.
- ⑪ **INPUT SELECTOR knob** - [22]
Use to select the input sources.
- ⑫ **VOLUME CONTROL knob** - [22]
⑬ **MAIN POWER key**
Use to turn the POWER ON/OFF.
- ⑭ **PHONES jack** - [24]
Use for headphone listening.
- ⑮ **DIRECT key** - [28]
⑯ **MEMORY key** - [29]
Use to store radio stations in the preset memory.
- ⑰ **SPEAKERS A/B keys** - [22]
Use to turn the speakers ON/OFF.
- ⑱ **TAPE 2(MONITOR) key** - [26]
Use to monitor a recording.
- ⑲ **LINE STRAIGHT key** - [24] - [32]
Use to listen with high quality sound.
- ⑳ **BALANCE keys** - [23]
Use to adjust the volume balance between left and right.
- ㉑ **VISUAL FIX key** - [14] - [22]
Use to lock on to the current video input.
- ㉒ **AUTO key** - [21]
Use to select the auto tuning mode.
- ㉓ **TUNING keys** - [22]
Use to tune in radio broadcasts.
- ㉔ **BAND key** - [27]
Use to select the broadcast band.
- ㉕ **LOUDNESS key** - [24]
Use to emphasize deep base sounds.
- ㉖ **VIDEO-3 terminals** - [8]

REMOTE POWER switch STANDBY mode

When the receiver's power cord is plugged in to an AC outlet and the MAIN POWER key is turned ON, the STANDBY indicator will remain lit, regardless of the ON/STANDBY setting of the REMOTE POWER switch. This indicates that a small amount of current is being supplied to the receiver in order to back up the memory contents. This is called the Standby mode. When the standby indicator is lit, the receiver can be switched ON/STANDBY from the remote control.

Connecting the antennas

Make connections as shown below.
Do not connect the power cord to a wall outlet until all connections are completed.

Antenna terminal connections

- ➊ Push lever.
- ➋ Insert cord.
- ➌ Return lever.

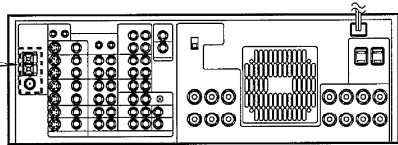
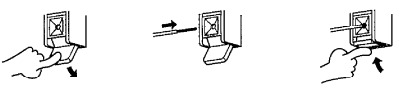

AM loop antenna

The supplied loop antenna is for use indoors. Place it as far as possible from the receiver, TV set, speaker cords and power cord, and adjust the direction for best reception.

AM loop antenna

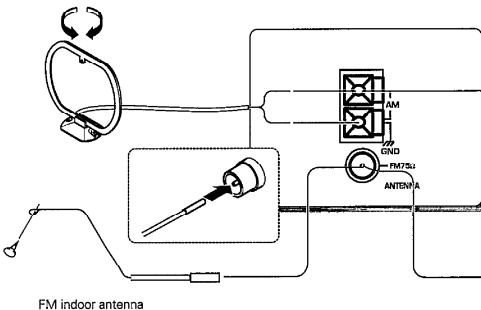

FM indoor antenna

FM indoor antenna

The supplied indoor antenna is for temporary use only. For stable signal reception we recommend using an outdoor antenna. Disconnect the indoor antenna when you connect one outdoors.

AM outdoor antenna

If reception is poor with the loop antenna, extend a vinyl-coated wire (more than 6 meters long) outdoors, without disconnecting the loop antenna.

AM outdoor antenna

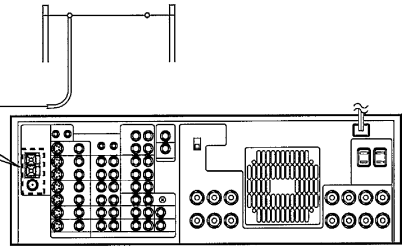

Use an optional antenna adapter

FM outdoor antenna

FM outdoor antenna

Lead the 75Ω coaxial cable connected to the FM outdoor antenna into the room and connect it to the FM 75Ω terminal.

FM DE-EMPHASIS / CHANNEL SPACE switch (Except for U.S.A., Canada and Australia)

The FM DE-EMPHASIS / CHANNEL SPACE switch on the rear panel is set to the correct setting that prevails in the area to which the unit is shipped. However, if the FM DE-EMPHASIS / CHANNEL SPACE setting is not matched to the area where the unit is to be used; for instance, when you move from area 1 to area 2 or vice versa, desired reception of AM / FM broadcasts is not expected. In this case, change the FM DE-EMPHASIS / CHANNEL SPACE setting in accordance with the area corresponding to the table. The FM DE-EMPHASIS is switched over at the same time.

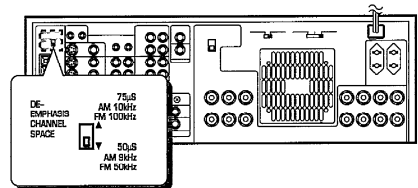

- When changing the setting of the FM DE-EMPHASIS / CHANNEL SPACE switch, first disconnect the power cord, then reset the channel space switch, connect the power cord again, and turn the power on.

Area	CHANNEL SPACE freq.	FM DE-EMPHASIS
1 U.S.A., Canada, and South American countries	FM: 100 kHz AM: 10 kHz	75 µs
2 Other countries	FM: 50 kHz AM: 9 kHz	50 µs

Connecting audio components

Make connections as shown below. When connecting the related system components, be sure also refer to the instruction manuals supplied with the components you are connecting. Do not connect the power cord to a wall outlet until all connections are completed.

Microcomputer malfunction
If operation is not possible or an erroneous display appears, even though all connections have been made properly, reset the microcomputer referring to "In case of difficulty".

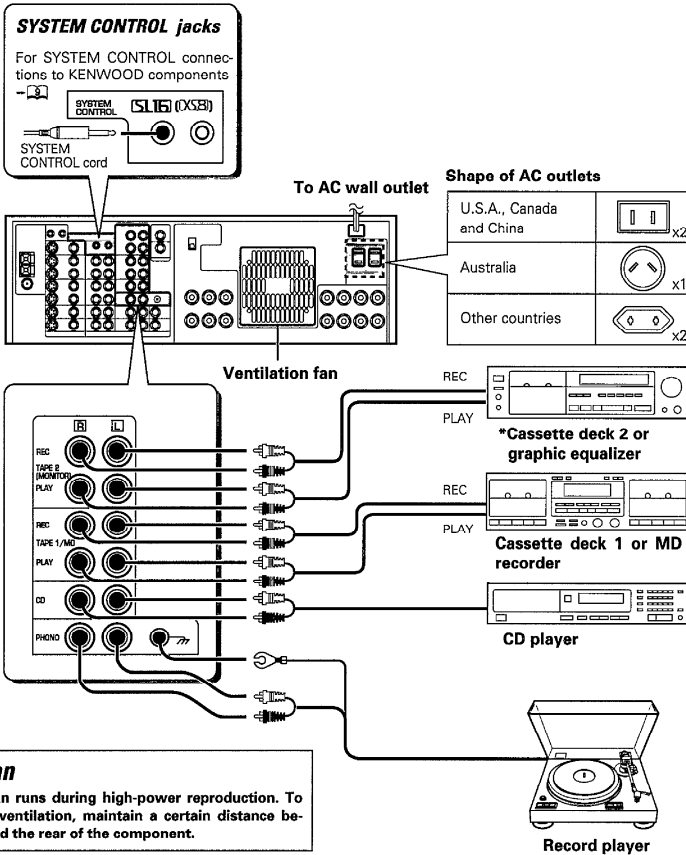

Ventilation fan

The ventilation fan runs during high-power reproduction. To allow for proper ventilation, maintain a certain distance between the wall and the rear of the component.

Caution regarding placement (except for U.S.A. and Canada)

To maintain proper ventilation, be sure to leave a space around the unit (from the largest outer dimensions, including projections) equal to, or greater than shown below: Left and right panels: 10 cm, Rear panel: 10 cm, Top panel: 50 cm

*** Do not connect a System Control cord to a cassette deck connected to the TAPE 2(MONITOR) jacks.**



1. Connect all cords firmly. Loose connections may prevent proper sound transmission or produce noise.
2. Be sure to remove the power cord from the AC outlet before plugging or unplugging any connection cords. Plugging / unplugging connection cords without disconnecting the power cord can cause malfunctions and may damage the unit.
3. Do not connect power cords from components whose power consumption is larger than what is indicated on the AC outlet at the rear of this unit.

Connecting video components

Make connections as shown below.

When connecting the related system components, be sure to also refer to the instruction manuals supplied with the components you are connecting.

Do not connect the power cord to a wall outlet until all connections are completed.

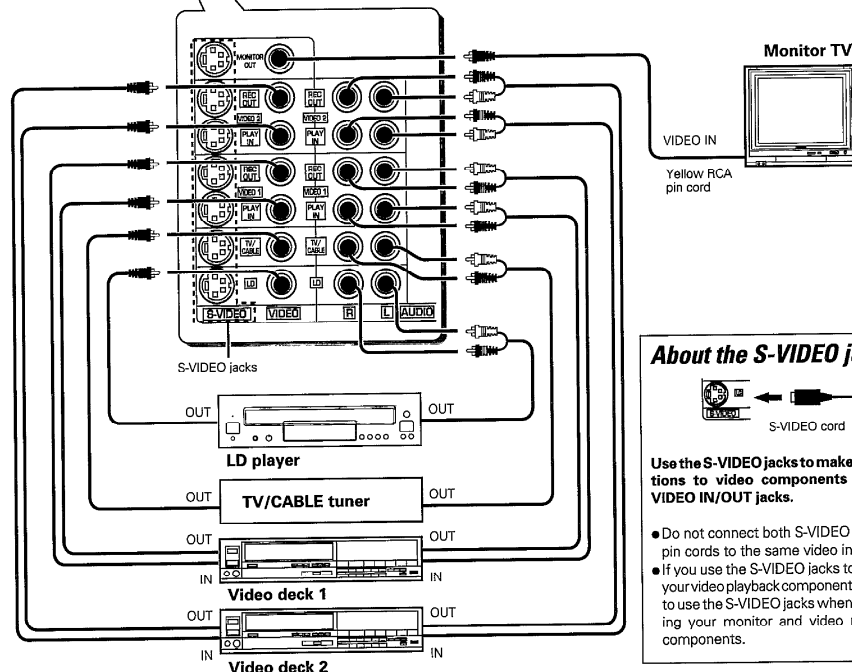
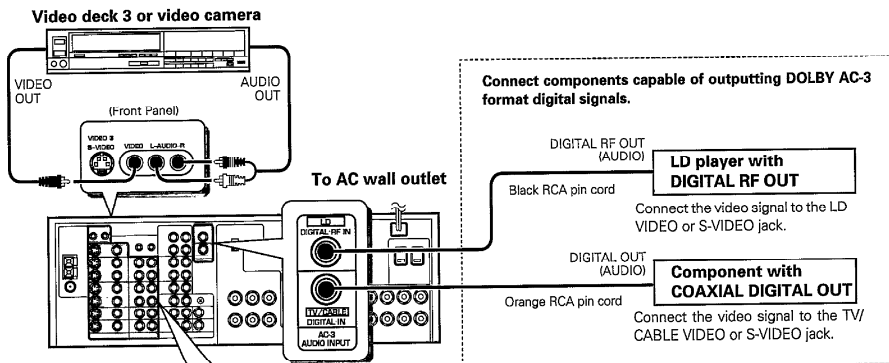

Video inputs and outputs
(Yellow RCA pin cords)

Audio inputs and outputs
(Red and white RCA pin cords)

Connecting the system control

Connecting system control cords after connecting a KENWOOD audio component system lets you take advantage of convenient system control operations.

There are two KENWOOD system control modes. Make connections according to the groups of terminal symbols shown below.

[XS8] Mode : lets you combine **[XS]**, **[XS8]**, and **[XR]** terminals

[SL16] Mode : for **[SL16]** terminals only

This unit is compatible with both [XS8] and [SL16] modes. It comes from the factory set to the [SL16] mode. To switch to the [XS8] mode, follow the instructions in "SWITCHING FROM [SL16] TO [XS8]" below.

EXAMPLE: [XS8] mode connections

The underlined portion represents the setting of the system control mode.

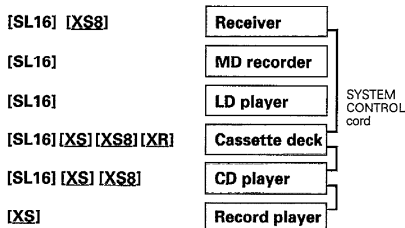

EXAMPLE: [SL16] mode connections

The underlined portion represents the setting of the system control mode.

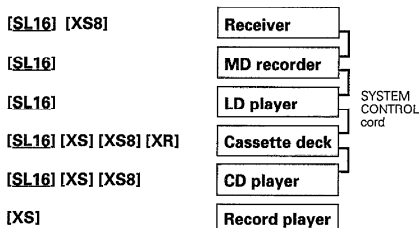

- Some CD players and cassette decks are not compatible with the [SL16] system control mode. Be sure to use the [XS8] system control mode when making system connections with equipment that is not [SL16] compatible.
- Some LD players and MD players are not system control compatible. You cannot make system control connections to this kind of equipment.

1. [SL16] equipment cannot be combined with [XR], [XS], and [XS8] equipment for system operations. If your equipment consists of this kind of combination, please do not connect any system control cords. Even without system control cords, normal operations can be carried out without affecting performance.
2. Do not connect system control cords to any components other than those specified by KENWOOD. It may cause a malfunction and damage your equipment.
3. Be sure the system control plugs are inserted all the way in to the system control terminals.

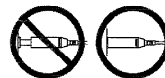

SYSTEM CONTROL OPERATIONS

Remote Control

Lets you operate this unit with the system remote supplied with the receiver.

Automatic Operation (except [XR] equipment)

When you start playback from a source component, the input selector on this unit switches to that component automatically. (Except for TAPE 2.)

Synchronized Recording (except [XR] equipment)

Lets you synchronize recording with the start of playback when recording from CD, MD, LD, or analog discs.



On-Screen system operation ([SL16] only)

This unit can display the current status of the component you wish to operate on the screen of a monitor television and let you operate that component with on-screen operations.

SWITCHING FROM [SL16] TO [XS8]

You can easily change the system control mode with the following operation. Do this operation after completing all connections.

Switching to [XS8] : Hold down the **BAND** key and switch the **MAIN POWER** key from OFF to ON.  

Switching back to [SL16]: Hold down the **AUTO** key and switch the **MAIN POWER** key from OFF to ON.  

- This operation will not affect items stored in the memory.

You can also change the mode using the On Screen Display.



The system control mode will revert to [SL16] if the unit is not turned on for three consecutive days. If you would like to make the unit completely (and permanently) [XS8] compatible, please consult your dealer.

SWITCHING THE TAPE 1 INPUT TO MD ([SL16] only)

If you set the SYSTEM CONTROL to the [SL16] mode and connect an MD recorder, be sure to switch the receiver's TAPE 1 input to MD. To switch the input, follow the steps shown below. (The input can also be switched through an on-screen operation.)

- ① Set the input to TAPE 1
- ② Hold down the **AUTO** key on the receiver for more than 2 seconds. Repeat to return to the original input setting (TAPE 1).

Connecting the speakers

- ① Strip coating.
- ② Loosen.
- ③ Insert.
- ④ Secure.

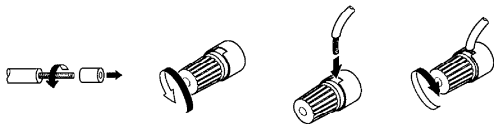

- Never short circuit the + and - speaker cords.
- If the left and right speakers are connected inversely or if the speaker cords are connected with reversed polarity, the sound will be unnatural with ambiguous acoustic imaging. Be sure to connect the speakers correctly.
- To emphasize deep bass sounds, connect a sub-woofer as desired.

IMPEDANCE SELECTOR switch for front speakers (see below)

FRONT SPEAKERS IMPEDANCE SELECTOR

A or B: 8Ω OR MORE

A or B: LESS THAN 8Ω

A and B: 8Ω OR MORE

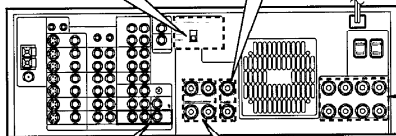

Front Speaker System A

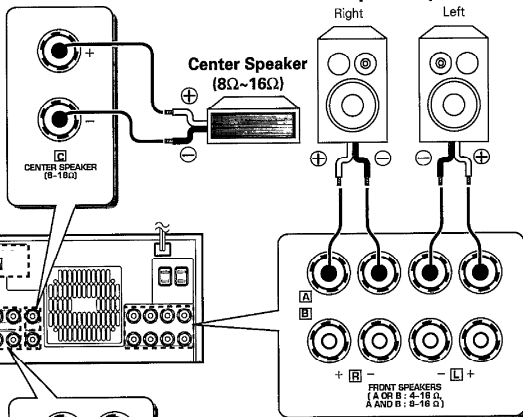

Use the FRONT SPEAKERS SYSTEM B terminals if you want to connect a second front speaker system.

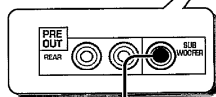

Powered sub-woofer

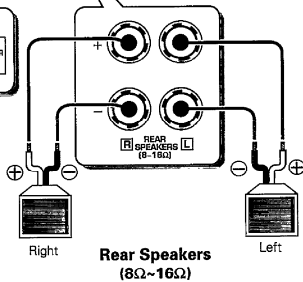

(Be sure to connect both rear speakers)

Connection of banana plugs (For U.S.A. and Canada only)

- ① Secure.
- ② Insert.



- Sound will not be heard if the speaker terminal is not fully secured.

Setting the FRONT SPEAKERS IMPEDANCE SELECTOR

When using FRONT SPEAKERS A and B separately.

Speaker impedance	Selector position
4Ω, 6Ω	
8Ω, 16Ω	

When using FRONT SPEAKERS A and B at the same time

Speaker impedance	Selector position
8Ω, 16Ω	

CAUTION: TO PREVENT FIRE, OR DAMAGE TO THE RECEIVER, SET THE IMPEDANCE SELECTOR SWITCH AS DESCRIBED BELOW.

Set the **IMPEDANCE SELECTOR** on the rear panel of the receiver according to the impedance of the speakers you plan to use.

- When the **IMPEDANCE SELECTOR** switch is set to **'A or B : LESS THAN 8Ω, A and B : 8Ω OR MORE'**, it is possible to use the A and B speakers at the same time.
- Therefore, when using the speakers A and B simultaneously, be sure to set the **IMPEDANCE SELECTOR** switch to the **'A or B : LESS THAN 8Ω, A and B : 8Ω OR MORE'** position.
- Set the **MAIN POWER** key to the OFF position when connecting speakers or adjusting the **IMPEDANCE SELECTOR**.

PRE OUT connections

Use these jacks if you want to listen at even greater volumes or enjoy a different sound quality.

Connecting a speaker cord directly to a PRE OUT jack will not produce any sound from the speaker. Connect the PRE OUT jacks to powered speakers or power amplifiers connected to speakers.

Be sure to set one of the SPEAKERS keys (either A or B) to the ON position when using the PRE OUT jacks.

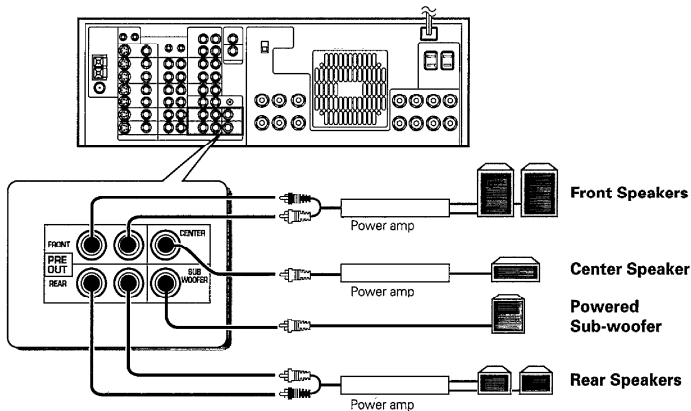

Connecting the repeater

Setting up the repeater lets you control your video components with the receiver's remote control. This repeater sends out signals corresponding to those of the remote supplied with your video equipment. There are 2 repeater jacks on the rear panel. One is for the supplied repeater. Depending on the repeater and the locations of your video components, it may not be possible to control all your video components with just one repeater. If you would like to use 2 repeaters, please consult your dealer.

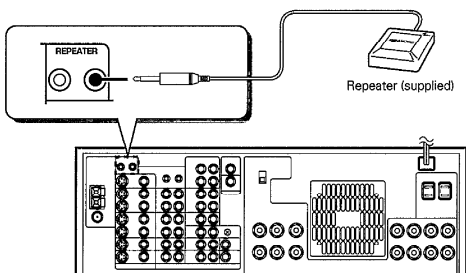

Placement

This repeater outputs infrared ray remote control codes in three directions (shown at right). Use the supplied double-sided tape to secure the repeater in a position where it can operate your video components. The range of operation depends on the shape and size of your room. Place the repeater so that there are no obstacles between the repeater and the remote receptors on your video components. Obstacles may prevent remote operation of your video components.

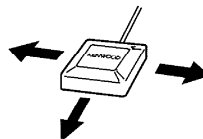

Remote control code output directions

How to use the remote control

KR-V990D (En)

This remote control has 3 operating modes; the function of each key changes accordingly.

Graphical User Interface (GUI) mode Lets you operate the receiver (and related components) by moving a hand that appears on the screen of your monitor TV.

KENWOOD mode This mode lets you operate the receiver, and other KENWOOD source components, like cassette decks and CD players, using this remote control. (The component you want to operate must be connected with a SYSTEM CONTROL cord. - [17] - [31])

Video mode Lets you operate both KENWOOD and other video components. (The appropriate setup codes must be entered beforehand. - [18])

Certain operation keys have different functions in different operation modes. Be sure to set the remote to the correct mode before operation. This section explains basic operating procedures and the KENWOOD operation mode.

To use the GUI mode - [14]
 To operate non-KENWOOD components - [34]

Names and functions of keys

Numbered keys have different functions in different modes. For details, see the "Remote control key operation table". - [13] - [24]

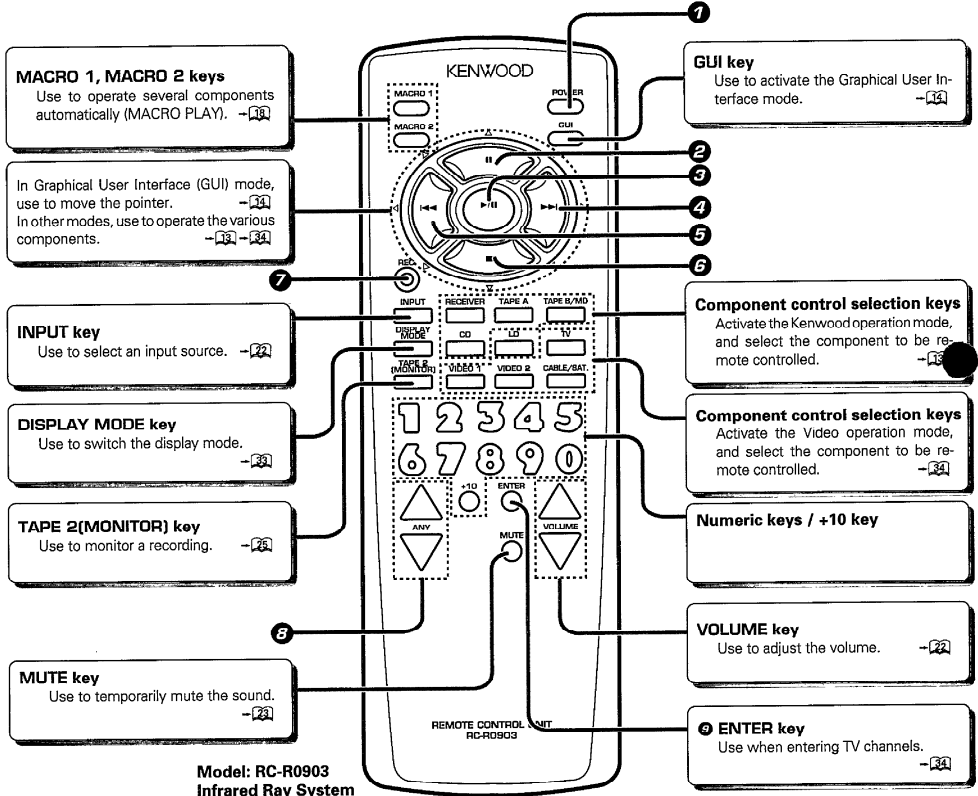

Loading the batteries

① Remove the cover.

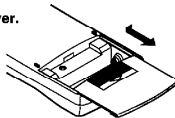

② Insert the batteries.

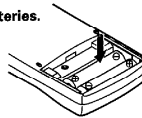

③ Close the cover.

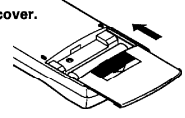

● Insert two AA-size (R6 / SUM-3) batteries as indicated by the polarity markings.

Operations

- 1** Turn on the receiver.
- 2** Set the input selector to the component you want to control.
- 3** Use a component control selection key to select the component you want to control.
- 4** Refer to the "Remote control key operation table" and press the key corresponding to the operation you desire.

Operating distance

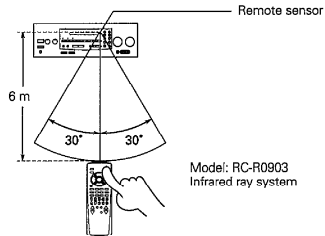

- When pressing keys in succession, press each key firmly and be sure to wait at least 1 second before pressing the next key.

Remote control key operation table

Component control selection keys	RECEIVER 	TAPE A or TAPE B/MD (for TAPE B)	CD 	LD (System Control operation)	TAPE B/MD (For MD)
1 POWER key	REMOTE POWER key	—	—	—	—
2 II key	—	II (Pause)	—	—	II (Pause)
3 ▶/II key	BAND key	▶ (Play)	▶/II (Play/Pause)	—	▶ (Play)
4 ▶▶ key	P.CALL (Δ) key (When the input is set to TUNER)	▶▶ (Fast forward)	—	▶▶ (Skip)	—
5 ◀◀ key	P.CALL (▽) key (When the input is set to TUNER)	◀◀ (Rewind)	—	◀◀ (Skip)	—
6 ■ key	AUTO key (When the input is set to TUNER)	—	—	■ (Stop)	—
7 REC key	—	● (Record)	Disc Skip	—	● (Record)
8 ANY key (Δ)	TUNING (Δ) key (When the input is set to TUNER)	▶ (Play)	—	▶▶ (Search)	—
ANY key (▽)	TUNING (▽) key (When the input is set to TUNER)	◀ (Play)	—	◀◀ (Search)	—

- Note**
1. The supplied batteries may have shorter lives than ordinary batteries due to use during operation checks.
 2. Replace both batteries with new ones when you notice a shortening of the distance from which the remote control will operate.
 3. Placing the remote sensor in direct sunlight, or in direct light from a high frequency fluorescent lamp may cause a malfunction. In such a case, change the location of the system installation to prevent malfunction.

Using the OSD (On Screen Display)

KR-V880D (En)

This receiver incorporates an on screen display (OSD) feature to provide information in large easy to read characters and to simplify operation. OSD lets you carry out three types of operations using the remote control's GUI (graphical user interface) mode. But first, lets see what kind of screen OSD provides.

Switching to the GUI (Graphical User Interface) mode

1 Turn on the components you want to use.

- Set the **MAIN POWER** key to the ON position.
- Set the **REMOTE POWER** key to the ON position.
- Turn on the connected monitor TV.

2 Activate the GUI mode.



This is the first display that appears when you activate the GUI mode.

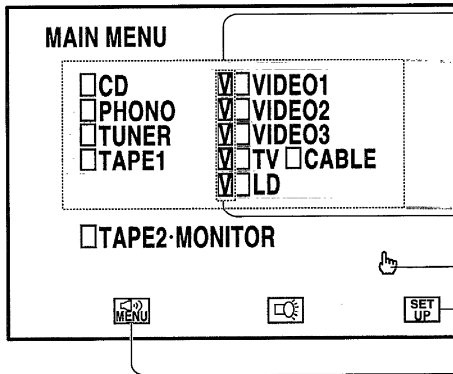

3 Switch input sources and operate other components.

The current input is displayed in blue. When you select another source, the input switches and the operation screen for that component is displayed (except for VIDEO 3 and PHONO).

VIDEO input display

Red: Represents the current video input.

Blue: Shows that the video input is locked (VISUAL FIX).
"VISUAL FIX" → [22]

Pointer

Move this hand (pointer) to conduct on-screen operation

1 Create an ideal AV environment.

2 Select surround modes on-screen.

Here's what you can do in GUI mode

1 Create an ideal AV environment (Set Up).

You can set up your AV system for efficient operation of all the audio and video equipment connected to this receiver. Set according to your equipment. (SYSTEM SET UP)

This mode also lets you complete the required surround setup. Once surround setup is complete, you may not need to adjust it again unless you change (or add) speakers. (SURROUND SET UP)

It may seem tedious but after you complete these set up operations, you will have a fully integrated AV system.

2 Select surround modes on-screen.

The receiver lets you choose from various home theater operations while looking at the screen of your monitor TV. So you can stay seated for simple operations.

3 Switch input source and operate other components.

The GUI mode also lets use the monitor TV screen for basic operations of components connected to the receiver with SYSTEM CONTROL cords. With the [SL16] mode, the current status of the source component is displayed in red.

You can also conduct basic operations of video components by entering the remote control set up code. In this case, the current status of the video component is not displayed.

Since the icons shown on the monitor TV are similar to the symbols on the operation keys of each source component, also check the operating instructions supplied with the source components during operation.

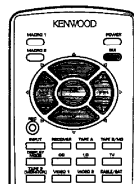

Keys or controls used in this operation.

Operating in GUI mode

On-screen operation in GUI mode consists of moving the hand shaped pointer icon to select items from the screen. First of all, lets try moving the pointer freely and selecting an item.

1 Activate the GUI mode.

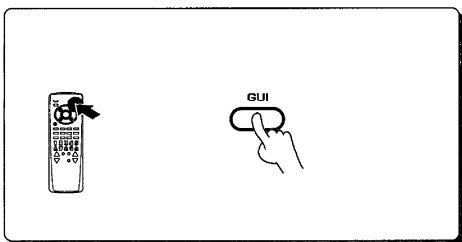

- The remote control switches to the on-screen operation mode.
- If no menus are displayed on screen, GUI mode is activated. If a menu is displayed, GUI mode is cancelled.

MAIN MENU screen

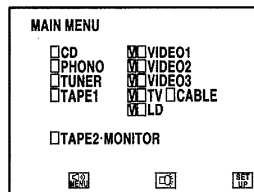

2 Move the pointer.

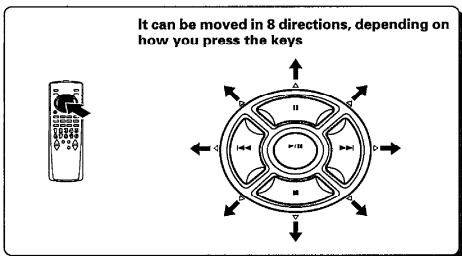

EXAMPLE: moving the pointer downwards toward the right.

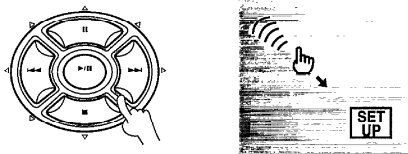

Press the \triangleright and ∇ keys at the same time.

- You can move the pointer in up to 8 different directions by pressing different key combinations. Try moving the pointer around the screen in different directions.

3 Press the item you desire.

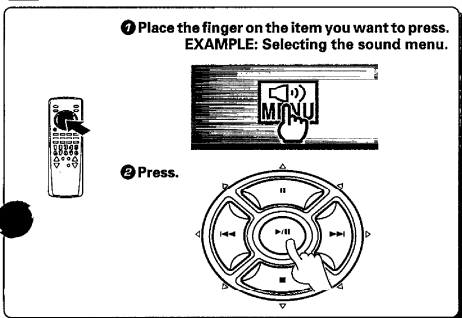

- To select an item, press the \triangleright /|| key located in the center of the remote control after moving the finger of the pointer on top of the item you want to select.

The SOUND MENU screen appears.

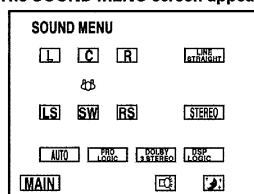

Convenient items for on-screen operation

Convenient and often used items are displayed at the bottom of the screen for you to use as necessary. If an item cannot be used with a certain menu, it will not be displayed.

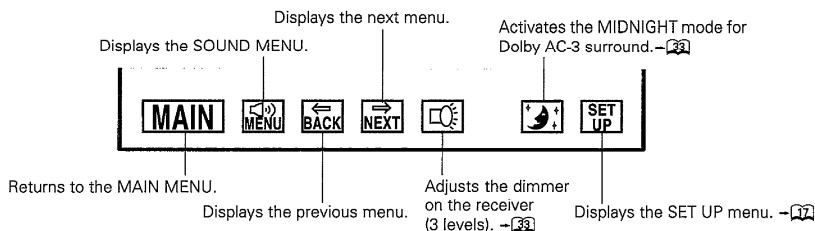

Screen menu structure

Below is a general outline of the screen menu structure. Choose the menus according to the screens you wish to access. Refer to the circled numbers shown below and see the "OSD flow chart" for information about the contents of each screen. → [29]

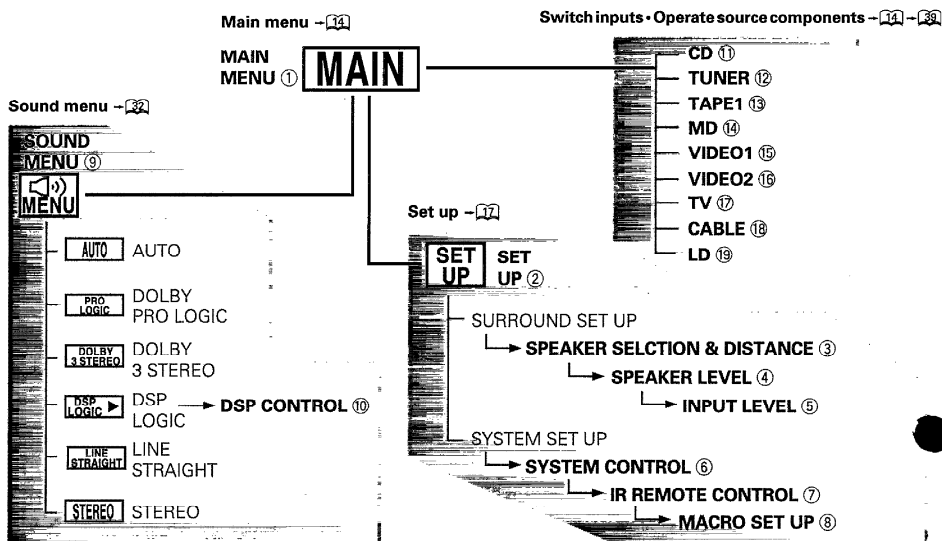

Preparing for playback (SET UP)

KR-V930D (Er)

Use the SET UP menu to create an ideal AV operating environment by matching the system control functions to your components. The SET UP menu arranges for proper control of other KENWOOD components and systems, as well as video equipment from other manufacturers.

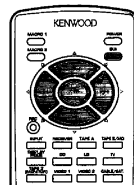

Preparations

- Turn on your monitor TV.

Keys or controls used in this operation.

System set up

1 Choose the SYSTEM SET UP menu.

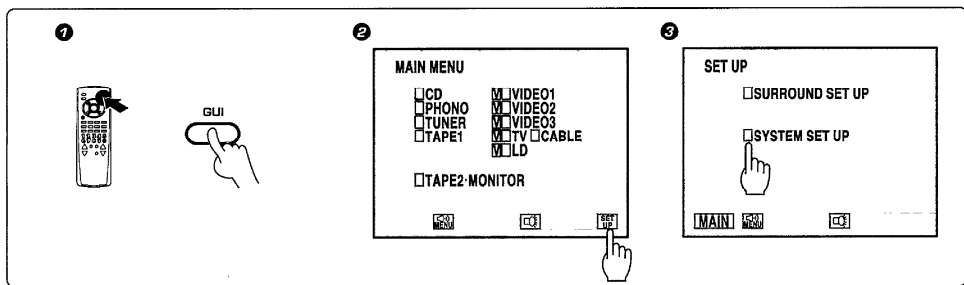

Set the SYSTEM CONTROL.

Set the KENWOOD system control. For details regarding SYSTEM CONTROL, see "Connecting the system control".

1 Choose a SYSTEM CONTROL mode.

This switches the KENWOOD SYSTEM CONTROL mode. For details regarding SYSTEM CONTROL, see "Connecting the system control".

- If you switched the SYSTEM CONTROL mode in "System connections", check to make sure the mode is correct and go to the next step.
- If the POWER is not turned on for 3 days, the SYSTEM CONTROL mode will automatically return to [SL16]. To set the receiver to [SL16] permanently, consult with your dealer.

2 Choose how to operate your LD player.

When you use a SYSTEM CONTROL cord to connect a KENWOOD LD player compatible with the [SL16] system control mode, choose the SYSTEM CONTROL and IR remote operations.

3 Choose either TAPE 1 or MD ([SL16] only).

This determines which component can be operated by the SYSTEM CONTROL. The input you select can then be chosen with the input selector.

- When the SYSTEM CONTROL is set to [SL16], and a [SL16] mode compatible KENWOOD MD recorder is connected to the TAPE1/MD jacks, select "MD".

4 Continue to next screen.

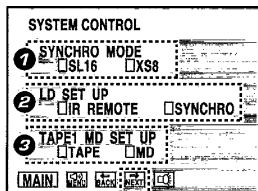

continued on next page

3 Setting up the IR REMOTE CONTROL.

Before operating video components using remote control supplied with this receiver, you need to input the setup code that corresponds to the IR remote control of the component you want to control.

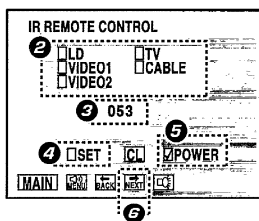

1 Look up the setup code for the component you want to control .

Use the "Setup Code Chart" to look up the setup code after determining the maker and the remote control capabilities of the component you wish to control. → [35]
EXAMPLE: To enter the setup code for a KENWOOD VCR → 053, 056 and 082
 If there is more than one setup code, input each code to see which one turns the power on. That will be the correct code for your component.

2 Select the input corresponding to the component you want to control .

Select VIDEO 1 or VIDEO 2.

3 Enter the setup code (3 numbers).

Use the remote control's numeric keys to enter "0 5 3".

4 Select SET.

5 Select POWER and check to see that the component you want to control turns on.

If the component does not turn on, and there is more than one setup code, enter another setup code and try again.
 • If you choose POWER when setting the mode for the current monitor TV, the monitor TV will turn off and you will not be able to see the screen. In this case, press the enter (▶/■) key on the remote control again. The monitor TV turns on, and the set up screen is displayed.

6 Repeat steps 1 ~ 5 to enter setup codes for all the components you want to control, then continue to the next screen.



Although each setup code is designed to work with a number of different models, certain codes may not work with some models. (Also, certain codes may only operate some of the functions available on a given model.)

4 MACRO SET UP.

This section shows you how to set the receiver to control several components in succession (MACRO PLAY). After completing this setup, you can perform a series of operations automatically, simply by pressing the **MACRO1** or **MACRO2** key. Enter the setup codes for the video components you want to control beforehand.

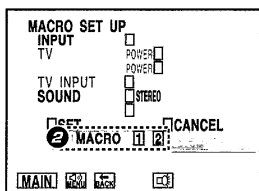

1 Determine the order of the operations you want set as a MACRO PLAY.

EXAMPLE : Turn the receiver's power ON → Set the INPUT on the receiver to VIDEO1 → Set the sound mode to DOLBY PRO LOGIC → Turn the monitor TV ON → Switch the input on the monitor TV → Turn the VCR ON → start playback from the VCR.

For this example ,we'll store these operations as MACRO1.

2 Select the macro number you want to set.

Select 1.

continued on next page

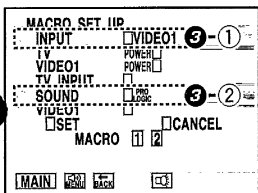

④ Enter the commands for the receiver.

① Set the receiver's input selector to the source you want to play. This setting also turns on the receiver (when the **MAIN POWER** key set to the ON position.)

The INPUT changes as follows:

none → CD → TAPE1A (deck A) or MD → TAPE1B (deck B) or MD → LD → VIDEO1 → VIDEO2 → TV → CABLE → none

Select VIDEO1.

- If you connect a single cassette deck, select "TAPE1B" when selecting the TAPE 1 input.
- To playback from audio components, make system control connections to KENWOOD audio components beforehand.

② Select the SOUND mode by referring to "Sound modes". → ③

The mode changes as follows:

STEREO → PRO LOGIC → AUTO → DOLBY 3 STEREO → DSP LOGIC → STEREO

Select PRO LOGIC.

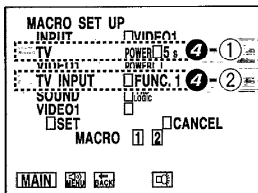

④ Enter the commands for your monitor TV.

① Set the timing for the monitor TV commands. Your monitor TV may not be able to receive remote commands immediately after the POWER ON signal. This setting lets you turn ON the monitor TV and program a delay before the next signal.

The timing changes as follows:

none (no POWER ON signal; sends remote command immediately) → 1s (sends command 1 second after POWER ON) → 5s (5 seconds after) → 10s (10 seconds after) → none

Select 5s.

② Set the command necessary to switch your monitor TV input in order to view video playback. First, determine how many times you have to press the input selector on your monitor TV to reach the correct video input, then set that number (FUNC.1, 2). If you watch videos by choosing a TV channel instead of switching the input, set the correct channel (TV1CH, TV2CH, TV3CH).

The setting changes as follows:

none (0 times) → FUNC.1 (1 time) → FUNC.2 (2 times) → TV1CH → TV2CH → TV3CH → none

- If your TV switches to VIDEO when you press the input selector once: → Select FUNC.1

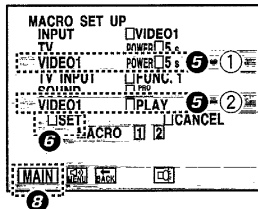

④ Enter the commands for your playback source (VCR).

① Set the timing for the command of the video components, such as a VCR. It is also necessary to program a delay between the POWER ON and PLAY signals for your playback source.

The timing changes as follows:

none (no POWER ON signal; sends remote command immediately) → 1s (sends command 1 second after POWER ON) → 5s (5 seconds after) → 10s (10 seconds after) → none

Select 5s.

② Set the operation mode for the playback source. If the playback source is a TV (etc.), use the remote's numeric (and ENTER) keys to select the channel.

Select PLAY.

⑥ Select SET.

This completes the setup for MACRO1.

⑦ To enter another MACRO SET UP, repeat steps ①-⑥.

⑧ Go back to the main menu.

⑨ Press the GUI key on the remote to turn off the on-screen display.

To use the MACRO PLAY



MACRO 1



MACRO 2



① Load the video (or audio) software.

- Remove video (or audio) software from all other connected components.

② Press MACRO1 or MACRO2 when the receiver's MAIN POWER switch is set to ON to carry out the operations set in the respective macro.

- If you set the macro to turn ON the power to your video components in steps ④-① and ④-①, be sure those components are turned OFF when you press the **MACRO** key. If they are turned ON when you press the **MACRO** key, they will be turned OFF.

This completes the system setup. If you add a new component or change a component, be sure to return to SYSTEM SET UP and correct the settings that apply to the component that was added or changed.

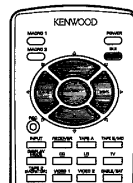

Keys or controls used in this operation.

Surround set up

To obtain the most possible enjoyment from the receiver's various surround modes, be sure to complete the surround set up as shown below.

1 Speaker placement.

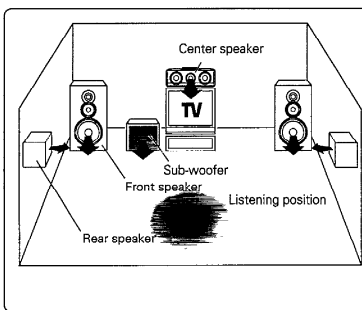

Front speakers :Place to the front left and right of the listening position. Front speakers are required for all surround modes.

Center speaker :Place front and center. This speaker stabilizes the sound image and helps recreate sound motion. Be sure to connect a center speaker when using the Dolby 3 Stereo mode.

Rear speakers :Place to the direct left and right, or slightly behind, the listening position at even heights, approximately 1 meter above the ears of the listeners. These speakers recreate sound motion and atmosphere. Required for surround playback.

Sub-woofer :Reproduces powerful deep bass sounds.

• Although the ideal surround system consists of all the speakers listed above, if you don't have a center speaker or a sub-woofer, you can divide those signals between the available speakers in the following steps to obtain the best possible surround reproduction from the speakers you have available.

2 Go to the SURROUND SET UP screen.

1

GUI

2

MAIN MENU

<input type="checkbox"/> CD	<input type="checkbox"/> VIDEO1
<input type="checkbox"/> PHONO	<input type="checkbox"/> VIDEO2
<input type="checkbox"/> TUNER	<input type="checkbox"/> VIDEO3
<input type="checkbox"/> TAPE1	<input type="checkbox"/> TV CABLE
	<input type="checkbox"/> LD

TAPE2-MONITOR

[M] [C] [S]

3

SET UP

[S] SURROUND SET UP

[M] [S] [C]

3 Select the speakers and enter the speaker distance.

SPEAKER SELECTION&DISTANCE

[L]	[C]	[R]	[LS]	[RS]	[SW]
<input checked="" type="checkbox"/>	<input checked="" type="checkbox"/>	<input checked="" type="checkbox"/>	<input type="checkbox"/>	<input type="checkbox"/>	<input type="checkbox"/>
			00 ft	0.0 m	
			00 ft	0.0 m	

DELAY TIME 20ms AC 05ms

[MAIN] [M] [C] [S]

1 Select the speakers you connected to the receiver.

When you select the icons for the speakers you connected, they turn grey.

L,R Front speakers (left and right) : Are already selected.

C Center speaker : Switches each time the icon is pressed

SMALL → select when using a relatively small center speaker.

LARGE → select when using a relatively large center speaker.

LS, RS Rear speakers (left and right) : LS and RS are selected at the same time.

SW Sub-woofer

continued on next page

What's delay time?

The sound you hear is composed of sound that comes to your ears directly from the sound source (direct sound), and sound that is reflected off the walls, floor, and ceiling of your room (reflected sound). Reflected sounds arrive at your ears slightly later than the direct sounds. Delay time is the difference in arrival time between the direct sound and the reflected sound.

This receiver sets the appropriate delay time automatically when you input the speaker distance.

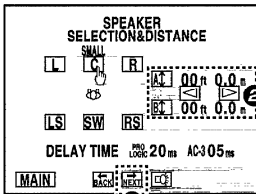

2 Enter the speaker distance.

(A) is the distance from the listening position to the front speakers.

(B) is the distance from the listening position to the rear speakers.

To enter the distance:

- ① Choose A \updownarrow (or B \updownarrow)
- ② Use \leftarrow and \rightarrow to enter the appropriate distance (from 0m(0ft) to 9m(30ft)).

- The delay time is calculated automatically when you input the speaker distance.
- The Dolby AC-3 mode and the Dolby Pro Logic mode have different delay times.

3 Continue to the next screen.

4 Adjust the volume levels of each speaker.

A test tone is emitted from the speaker displayed in red. Listen to the test tone and adjust the volume level of each speaker so that they produce the test tone at the same volume level as the front speakers.

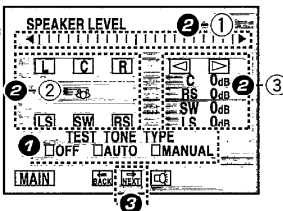

1 Select the test tone type.

- AUTO : The test tone is switches between each speaker in regular intervals.
 MANUAL : The test tone only comes from the speaker you select (displayed in red).
 OFF : Stops the test tone.

2 Adjust the Volume level of each speaker.

- ① Use the \leftarrow and \rightarrow icons to adjust the balance between the front (left and right) speakers.
 - The name of the selected channel (on the right side of the screen) turns red, to show that it can be adjusted.
- ② Listen to the test tone and select the speaker you want to adjust.
 - The name of the selected channel (on the right side of the screen) turns red, to show that it can be adjusted.
- ③ Listen to the test tone and adjust the volume level of the speaker.
 - \leftarrow : Lowers the volume \rightarrow : Raises the volume
 - Adjust the sub-woofer as you desire.

3 Continue to the next screen.

5 Adjust the audio input level of the connected components.

The OVER LEVEL indicator lights during playback the signal being input from an analog source is too large. If this occurs, use this screen to attenuate the input level for that source.

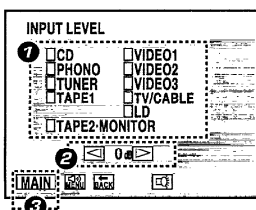

1 Select the input.

2 Select an input level.

The input level is adjustable in 3 levels. Choose the smallest level required to extinguish the OVER LEVEL indicator (normally, set to 0 dB).
 0 dB \leftrightarrow -3 dB \leftrightarrow -6 dB

3 Return to the main menu.

4 Press the GUI key on the remote to turn off the on-screen display.

This completes the surround setup. If you add a new component or change a component, be sure to return to SYSTEM SET UP and correct the settings that apply to the component that was added or changed.

Normal playback

KR-V9900 (En)

- Preparations**
- Turn on the power to the related components.
 - Set the **MAIN POWER** key to the ON position.

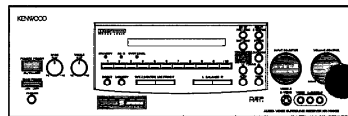
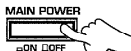

Keys or controls used in this operation.

Listening to a source component

1 Turn on the receiver.

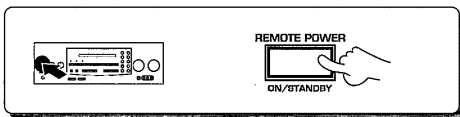

2 Select a speaker system.

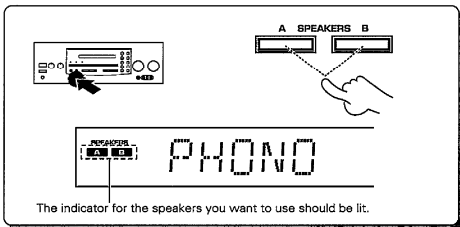

- A ON** : Sound from the speakers connected to the SPEAKERS A terminals on the rear panel.
- B ON** : Sound from the speakers connected to the SPEAKERS B terminals on the rear panel.
- A+B ON** : Sound from both the speakers connected to the SPEAKERS A and B terminals on the rear panel.
- A+B OFF** : No sound from the speakers. Use this setting when listening with headphones for stereo sound in all playback modes.

- When both SPEAKERS A and B are ON, activating a surround mode turns SPEAKERS B OFF automatically. In this case, to listen with SPEAKERS B, press the **SPEAKERS B** key; SPEAKERS A turn OFF automatically.

3 Select the source you desire.

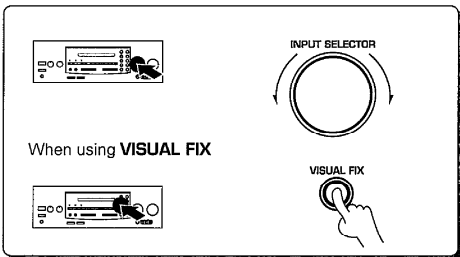

The input sources change as follows:

- ① TUNER (Frequency display)
- ② TAPE 1 (M1)
- ③ VIDEO 1
- ④ VIDEO 2
- ⑤ VIDEO 3
- ⑥ TV/CABLE
- ⑦ LD
- ⑧ CD
- ⑨ PHONO

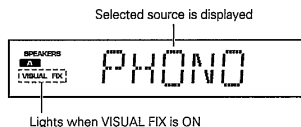

VISUAL FIX

The VISUAL FIX function lets you lock on to the current video input. For example, if you turn on VISUAL FIX before changing from VIDEO 1 to VIDEO 2, you can watch the images from VIDEO 1 while listening to the sound from VIDEO 2.

- The on-screen display (MAIN MENU) also lets you select, or check, audio and video input selections.

4 Start playback from the selected source.

5 Adjust the volume.

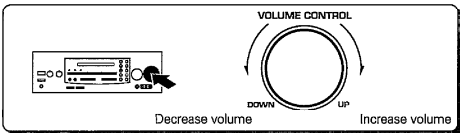

- If **TAPE 2(MONITOR)** is ON, you will not hear the selected input source.

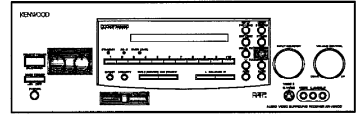
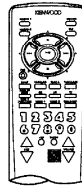

 Keys or controls used in this operation.

Adjusting the sound

Adjusting the tone

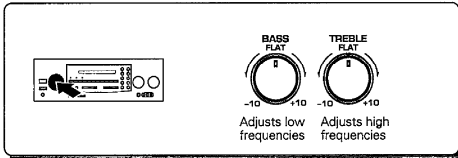

Adjusting the left and right balance

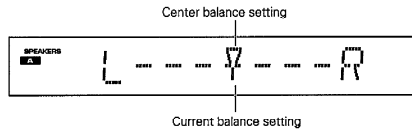
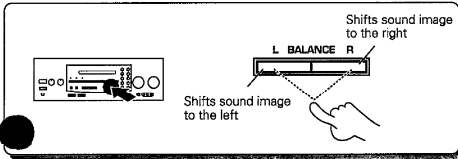

- You can also adjust the balance using the on-screen display (SPEAKER LEVEL).
- When playing back in surround sound, set the balance according to the adjustments shown in 'Surround set up'.

Emphasizing deep bass (LOUDNESS)

LOUDNESS lets you emphasize the sound of deep bass when listening at low volumes.

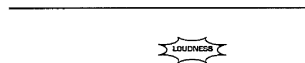
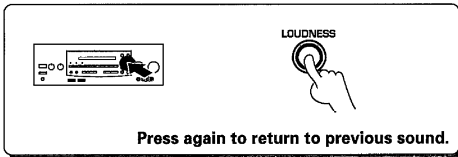

To cancel
Press again.

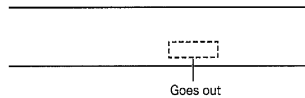

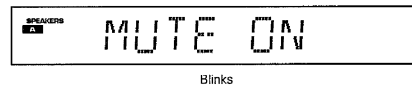
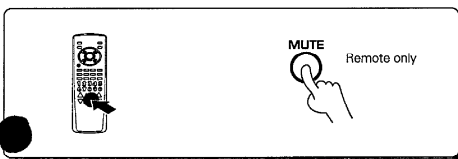

Muting the sound

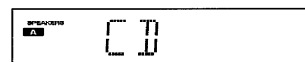

To cancel
Press again.

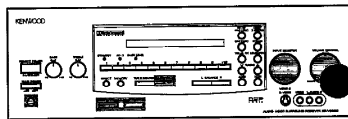



 Keys or controls used in this operation.



LINE STRAIGHT playback

Use this function for high quality playback of CD's (etc.).

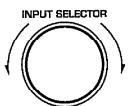
1 Select a playback source.

2 Press the LINE STRAIGHT key.





3 Start playback .

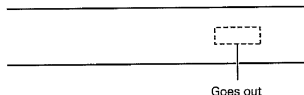

- Tone controls do not work during LINE STRAIGHT playback.
- Pressing any of the keys related to surround playback will cancel LINE STRAIGHT playback.
- You can also select LINE STRAIGHT from the on-screen display (SOUND MENU).
- LINE STRAIGHT playback cannot be used when using only digital inputs.
- No signal is output to the sub-woofer during LINE STRAIGHT playback.

To cancel
Press again.



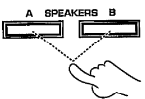

Listening with headphones

1 Turn OFF both speaker switches.

2 Connect headphones.

3 Adjust the volume.



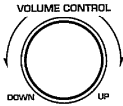

Decrease volume Increase volume

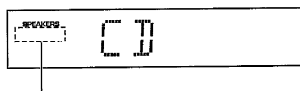

Make sure the SPEAKERS indicators are turned off.

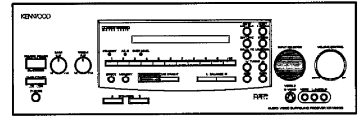
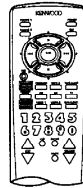
- Turning off both **SPEAKERS A** and **B** when using a surround mode, or LINE STRAIGHT playback, will cancel the respective mode and activate stereo playback.



 Keys or controls used in this operation.

Recording audio

Recording a music source

- 1 Select the source you want to record.

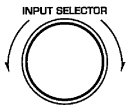

Select a source other than TAPE 1

- 2 Set the cassette deck to record.
- 3 Start playback, then start recording.

Dubbing tapes (TAPE 2 → TAPE 1)

- 1 Press TAPE 2(MONITOR).

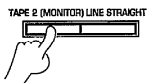
- 2 Set the input selector to a source other than TAPE 1.

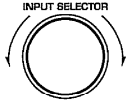

- 3 Start playback from TAPE 2, then start recording on TAPE 1.

Lights



● You can also select TAPE 2(MONITOR) using on-screen operation (MAIN MENU).

● When copying with a double cassette deck, refer to the operating instructions supplied with the deck.

Dubbing tapes (TAPE 1 → TAPE 2)

- 1 Set the INPUT SELECTOR to TAPE 1.
- 2 Start playback from TAPE 1, then start recording on TAPE 2.

TAPE 2 (MONITOR) function

You can connect either a cassette deck or a graphic equalizer to the receiver's TAPE 2 terminals. If you connect a graphic equalizer, the TAPE 2(MONITOR) key should be turned ON. If you connect a 3-head cassette deck, you can compare the source sound to the sound being recorded while recording. Press the TAPE 2(MONITOR) key to switch between the recorded sound to the source sound. For further details, refer to the operating instructions supplied with the component you connected.

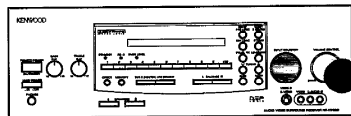

Keys or controls used in this operation.

Recording video

The following steps show how to record playback from VIDEO2 onto the video deck connected as VIDEO1. For details regarding operation of the video components, refer to the operating instructions supplied with the components.

1 Connect the component you want to record.

- Connect the source you want to record to the VIDEO2 terminals.
- You can connect video decks (playback only), video cameras (playback only), LD players, BS tuners, etc.

2 Set the input to "VIDEO 2".

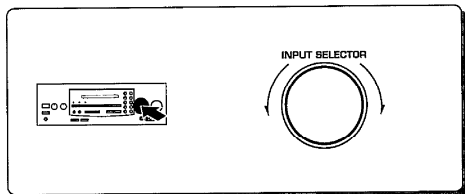

The input sources change as follows:

- ① TUNER (Frequency display)
- ② TAPE 1 (M1)
- ③ VIDEO 1
- ④ VIDEO 2
- ⑤ VIDEO 3
- ⑥ TV/CABLE
- ⑦ L I
- ⑧ C I
- ⑨ PHONO

"VIDEO 2" appears in the display.

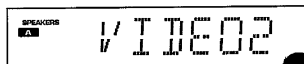

3 Start playback from the component you want to record.

4 Start recording on the video deck.

- Start recording on the deck connected to VIDEO 1.
- By using the input selector to select the input terminals for the video component you wish to record, you can record video to and from other components in the same way.

Listening to radio broadcasts

KR-V9000 (Er)

This section shows you how to receive radio broadcasts. You can preset up to 40 stations, which can then be received with the touch of a single button.

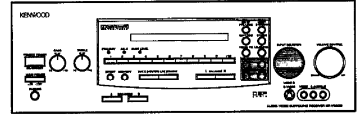

Keys or controls used in this operation.

Tuning radio stations

1 Set the input to tuner.

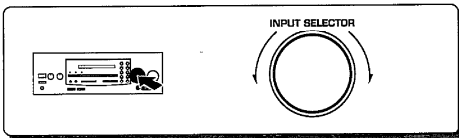

The input sources change as follows:

- ① TUNER (Frequency display)
- ② TAPE 1 (MD)
- ③ VIDEO 1
- ④ VIDEO 2
- ⑤ VIDEO 3
- ⑥ TV/CABLE
- ⑦ LB
- ⑧ CD
- ⑨ PHONO

Frequency display

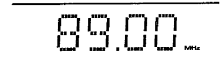

2 Select a broadcast band.

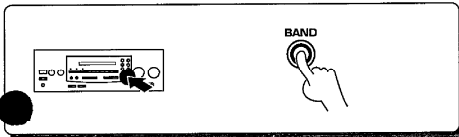

Each press switches the band as follows:

- ① FM
- ② AM

"AM" or "FM" is displayed

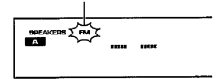

3 Select a tuning method.

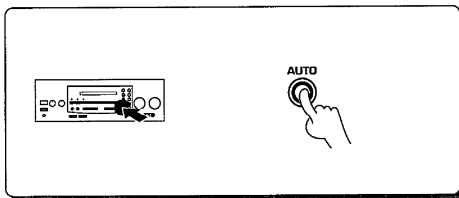

Each press switches the tuning method as follows:

- ① AUTO lights (auto tuning)
- ② AUTO goes out (manual tuning)

● Normally, set to auto tuning.



If the radio waves are weak and there is a lot of interference, switch to manual tuning. (With manual tuning, stereo broadcasts will be received in monaural.)

4 Select a station.

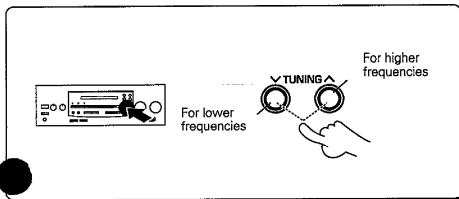

Frequency display

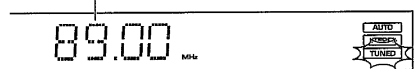

"TUNED" is displayed when a station is received

Auto tuning : Tunes the next station automatically.

Manual tuning: Press the **TUNING** keys repeatedly to tune the station.



 Keys or controls used in this operation.

Tuning radio stations by frequency (DIRECT tuning)

1 Set the input to tuner.

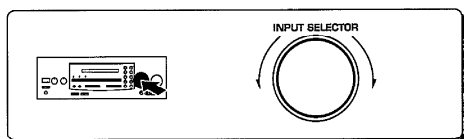

2 Select a broadcast band.

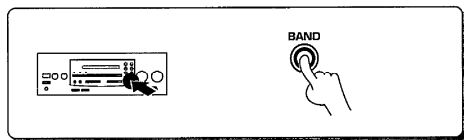

3 Enter the frequency.

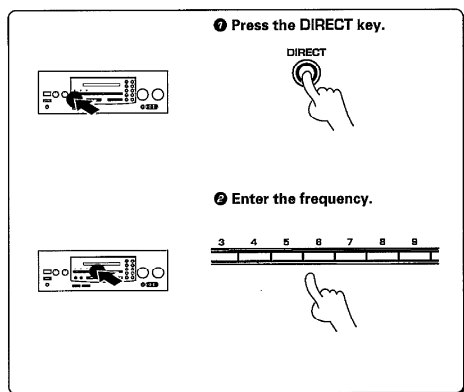

The input sources change as follows:

- ① TUNER (Frequency display)
- ② TAPE 1 (MB)
- ③ VIDEO 1
- ④ VIDEO 2
- ⑤ VIDEO 3
- ⑥ TV/CABLE
- ⑦ LD
- ⑧ CD
- ⑨ PHONO

Frequency display

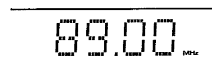

Each press switches the band as follows:

- ① FM
- ② AM

"AM" or "FM" is displayed

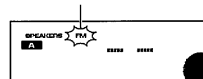

Press the numeric keys in the following order:

* AM 10 kHz/FM 100kHz tuning space (U.S.A., Canada, etc.)

- AM 810 kHz, press **8**, **1**
- AM 1260 kHz, press **1**, **2**, **6**
- FM 90 MHz, press **9**, **0**, **0**
- FM 102.5 MHz, press **1**, **0**, **2**, **5**

* AM 9 kHz/FM 50 kHz tuning space (other countries)

- AM 810 kHz, press **8**, **1**, **0**
- AM 1260 kHz, press **1**, **2**, **6**, **0**
- FM 90 MHz, press **9**, **0**, **0**, **0**
- FM 102.5 MHz, press **1**, **0**, **2**, **5**, **0**

* FM DE-EMPHASIS/CHANNEL SPACE switch. 

Frequency display



"TUNED" is displayed when a station is received.

• If you make a mistake entering the frequency, the frequency display will blink for a few seconds. In this case, start again from step 3.



 Keys or controls used in this operation.

Preparations

- Tune to the station you want to store. 
- Press the **RECEIVER** key on the remote to activate the receiver mode.

Presetting radio stations

1 Press the **MEMORY** key while receiving the station.





MEMORY





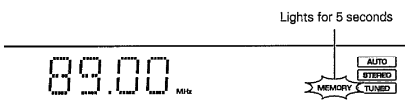

Proceed to step **2** within 5 seconds (If you wait longer than 5 seconds, repeat step **1**.)

2 Enter a preset number (1~40).

Press the numeric keys in the following order:

- For "15", press , 
- For "20", press , , 

- Repeat steps **1** and **2** and to store as many stations as necessary.
- If you store a station at a previously used preset, the old station will be replaced by the new one.

Receiving preset stations



1 Select tuner.







INPUT SELECTOR



2 Enter the number of the preset you want to receive (up to "40").





Press the numeric keys in the following order:

- For "15", press , 
- For "20", press , , 

- If you make a mistake entering a two digit number, press the  key several times to return to the original display and start again.

Receiving preset stations in order (PCALL)



Higher preset numbers

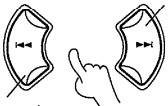

Lower preset numbers

- Each time you press the key, another preset station is received in order.

When you press  \rightarrow

$1 \rightarrow 2 \rightarrow 3 \rightarrow \dots \rightarrow 38 \rightarrow 39 \rightarrow 40 \rightarrow 1 \rightarrow 2 \rightarrow 3 \rightarrow \dots$

When you press  \leftarrow

$1 \leftarrow 2 \leftarrow 3 \leftarrow \dots \leftarrow 38 \leftarrow 39 \leftarrow 40 \leftarrow 1 \leftarrow 2 \leftarrow 3 \leftarrow \dots$

Holding down the button, lets you skip through the presets, receiving each for 0.5 seconds apiece.

Ambience effects

KR-V890D (En)

This receiver incorporates 4 different sound modes to let you enjoy surround sound with a wide variety of program sources. The Dolby AC-3 and Dolby Pro Logic surround sound let you enjoy theater-like surround effects when you play Dolby AC-3 and Dolby Pro Logic program sources (like Laserdiscs). Dolby 3 Stereo creates a panoramic frontal sound field while keeping dialog on screen. The Digital Signal Processing (DSP) modes, DSP Logic, let you create the atmosphere of a movie theater from almost any type of program source.

To obtain the best possible surround sound, be sure to complete "Surround set up" before using the surround modes. -- [10] -- [20]

Sound modes

Dolby AC-3

The Dolby AC-3 surround format lets you enjoy up to 5.1 channels of digital surround sound from Dolby AC-3 program sources (such as Laserdisc software marked

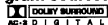

). Compared with previous Dolby surround, Dolby AC-3 provides even better sound quality, greater spatial accuracy, and improved dynamic range.

Some AC-3 programs carry information that lets you compress the dynamic range of the sound track, without degrading the sound quality, for softer sound effects when you listen late at night ("Midnight mode" -- [33]).

Note

Although a full set of speakers (front left, right, and center, rear left and right, and a sub-woofer) is required for true 5.1 channel Dolby AC-3 surround sound, this receiver lets you enjoy Dolby AC-3 (and Dolby Pro Logic) program sources, even if you connect only the front and rear, or center speakers. ("Surround set up" -- [20])

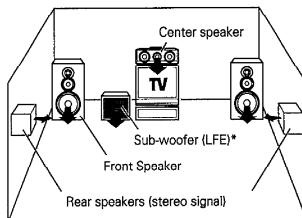

* LFE = Low Frequency Extension. This channel delivers separate non-directional bass signals to the sub-woofer for more dynamic deep bass sound effects.

Although only AC-3 soundtracks incorporate a separate low frequency channel, connecting a sub-woofer will also improve deep bass performance in the other surround modes.

Dolby Pro Logic

Dolby Pro Logic is a specially encoded 2 channel surround format designed to provide theater-like surround sound from Dolby Pro Logic program sources (such as video and Laserdisc software marked



). This receiver is equipped with a Dolby Pro Logic surround decoder to let you enjoy the wide variety of currently available Dolby Pro Logic home video software.

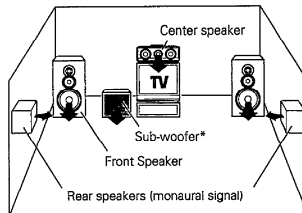

* Optional in this mode.

Dolby 3 Stereo

Dolby 3 Stereo creates a panoramic frontal sound field while maintaining the dialog in an on-screen position. This mode is designed for use with Dolby program sources, but can also improve sound field unity for non-Dolby program sources. Dialog positioning and sound image definition, however, may not be as accurate when used with non-Dolby program sources.

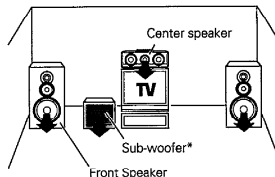

* Optional in this mode.



DSP Logic

DSP Logic transforms your listening room into either a SMALL or LARGE movie theater by using DSP to add delay and reverberation to signals processed by the Dolby Pro Logic surround decoder. These modes are most effective with Dolby Pro Logic program sources, but can also create a convincing theater-like atmosphere from a (non-Dolby) stereo signal.*

The EFFECT level lets you adjust the "presence" of the theater according to your preference. - [33]

*Spatial dynamics and sound image definition may not be as accurate when used with non-Dolby Pro Logic program sources.

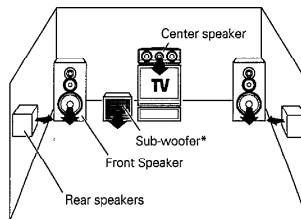

* Optional in this mode.

What's DSP?

DSP stands for Digital Signal Processor.



The way a sound is heard in an actual environment depends on a variety of different factors. One of the most important is reverberation (the act of decaying elements of sound echoing in various places).

The DSP modes produce the feeling of presence by using the DSP to create reverberation, without spoiling the sound quality of the original signal.

Manufactured under licence from Dolby Laboratories Licensing Corporation. "Dolby", "AC-3", "Pro Logic" and the double - D symbol are trademarks of Dolby Laboratories Licensing Corporation.

Playing back with surround sound

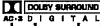
KR-V980D (En)

DOLBY AC-3 can be used when playing LD software bearing the  mark and DOLBY AC-3 format digital broadcasts (etc.). DOLBY PRO LOGIC and DOLBY 3 STEREO can be used when playing video or LD software bearing the  mark.
 DSP LOGIC can be used with any source. Be sure to complete "Surround set up" before using any of these surround modes. 

Preparations

- Turn ON related components.
- Complete "Surround set up". 
- Set the input to the component you wish to play back with surround sound.

1 Select the SOUND MENU.

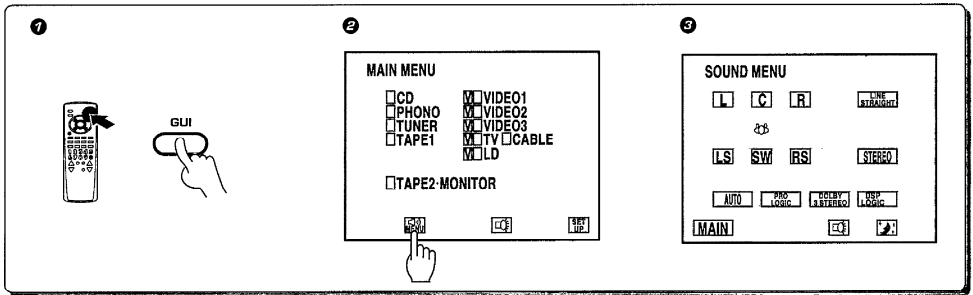

2 Select a surround mode.

Select the icon for the mode you desire. The selected icon turns blue.

Shows the speakers selected in SURROUND SET UP 

Midnight mode 

AUTO

This mode selects the appropriate Dolby surround mode automatically. When a Dolby AC-3 format signal is input, the surround mode switches to DOLBY AC-3. Otherwise, the surround mode is set to DOLBY PRO LOGIC. In some cases, depending on the number of channels being input and the type of speakers connected, the surround mode may switch to DOLBY 3 STEREO.

DOLBY 3 STEREO

Selects the DOLBY 3 STEREO mode.

DSP LOGIC

Turns on the current DSP LOGIC mode. Press the blue triangle (displayed when DSP LOGIC is turned on) to switch to the DSP CONTROL screen and set the DSP LOGIC mode and effect level.

LINE STRAIGHT

Lets you enjoy stereo playback with high sound quality.

STEREO

Cancels surround playback.

3 Start playing the video software.

- When playing sources in the Dolby AC-3 surround mode, the sound being played back may be interrupted until the receiver confirms that an AC-3 signal is being input (until the AC-3 indicator lights).

4 Adjust the volume.



To enjoy Dolby AC-3 surround (as well as all the other surround modes) from a single component, be sure to use a Dolby AC-3 compatible source component. Connect the Dolby AC-3 compatible source component's AC-3 format digital audio signal to the AC-3 INPUT terminal on the back of the receiver. Connect the normal audio signal correctly to the respective component's AUDIO jacks. 

To select a DSP LOGIC mode

Pressing the blue triangle (displayed when DSP LOGIC is turned on) in the DSP LOGIC icon on the SOUND MENU, displays the DSP CONTROL screen. Set the DSP LOGIC mode and EFFECT LEVEL as you desire.



DSP LOGIC mode setting

- LARGE** : Simulates the presence of a large movie theater.
- SMALL** : Simulates the presence of a relatively smaller movie theater.

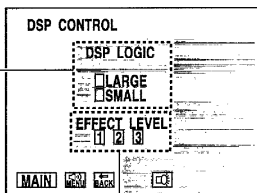

EFFECT LEVEL setting

Lets you choose from three different effect levels.

Convenient functions

Midnight mode (Dolby AC-3 mode only)

When watching movies at night you might not be able to raise the volume as loud as normal. Midnight mode compresses the dynamic range of previously specified parts of the AC-3 sound track (like scenes with sudden increases in volume) to minimize the difference in volume between the specified and non-specified parts. This makes it easy to hear all of the sound track, even when listening at low volumes.

Press to switch.



Yellow
Dark grey



Same color as screen

The indicator on the receiver also lights

- Some Dolby AC-3 software may not be compatible with the Midnight mode.
- Midnight mode has no effect on parts of the sound track that are not specified for compression.

DIMMER switch

The dimmer switch lets you adjust the brightness of the receiver's display in three levels. You might find this useful if you darken your room to watch movies or listen to music.

Press to switch.



Blue



Grey



Yellow



Blue

DISPLAY MODE key

Each time you press the **DISPLAY MODE** key on the remote control, the information shown in the receiver's display changes between the current input source and the current surround mode.

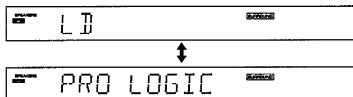

Remote controlling video components

KFR-V990D (En)

Refer to the following table for the type of remote control operations available for each video component. Each key on the table operates the selected component as shown in the respective column. (The set up code for each component must be entered beforehand. - [18])

















"Connecting the repeater" - [11]
"System set up" - [17]

How to operate video components

- 1** Turn on the receiver.
- 2** Set the input selector to the component you want to control.
- 3** Use a component control selection key to select the component you want to control.
- 4** Refer to the "Remote control key operation table" and press the key corresponding to the operation you desire.

● Be sure to point the remote control at the IR receptor on the receiver when operating the remote control, even when operating other components.

Remote control key operation table

Component control selection keys	LD LD 	VIDEO 1 VIDEO 1 	VIDEO 2 VIDEO 2 	TV TV 	CABLE/SAT. CABLE/SAT. 
Key names	(IR remote operation)				
1 POWER key 	Power On/Off				
2 II key 	II (Pause)			Video selector	
3 ►/II key 	► (Play)			_____	
4 ►► key 	►► (Skip)	►► (Fast forward)		Volume up	
5 ◀◀ key 	◀◀ (Skip)	◀◀ (Rewind)		Volume down	
6 ■ key 	■ (Stop)			Mute	
7 REC key 	_____	● (Record)		_____	
8 ANY key (Δ) 	►► (Search)	Channel up			
ANY key (▽) 	◀◀ (Search)	Channel down			
Numeric keys 	Numeric keys • +10 key				
9 ENTER key 	_____	Use after the numeric keys when entering a channel number. (See the operating instructions supplied with the component to be controlled for information about how to enter the channel.)			



Although each setup code is designed to work with a number of different models, certain codes may not work with some models. (Also, certain codes may only operate some of the functions available on a given model.)

Set up code chart

KF-V990D (En)

VCR Set up codes

Maker	Set up codes
ADVENTURA	015
AIKO	293
AIWA	015
AIWA	056,064,068,076,257
AMERICAN HIGH	050
ASHA	255
AUDIOVOX	052
BEAUMARK	255
BELL & HOWELL	119
BROKSONIC	136,199,226,310,376
CALIX	052
CANON	050,182
CAPEHART	035
CARVER	096
CCE	087,293
CITIZEN	052,293
COLT	087
CRAIG	052,062,087,255,286
CURTIS MATHES	050,056,075
CYBERNEX	255
DAEWOO	035,060,102,293
DAYTRON	039
DYNATECH	015
ELECTROHOME	052
ELECTROPHONIC	052
EMEREX	047
EMERSON	015,017,052,058,076,136,199,223,224,226,227,309,310,376
FISHER	062,069,081,119
FUJI	048,050
FUJIFILM	015
GARRARD	015
GE	050,075,080,217
GO VIDEO	247,294
GOLDSTAR	033,052,053
GRADIENTE	015
HARLEY DAVIDSON	015
HARMAN/KARDON	053,090
HARWOOD	087
HEADQUARTER	061
HI-Q	062
HITACHI	056,057,080,097,120,181
JENSEN	056
JVC	023,056,082
KENWOOD	053,056,082
KLH	087
KODAK	050,052
LLOYD	015
LLOYD'S	223
LOGIK	087
LXI	052
MAGNAVOX	050,054,096,125,164
MAGNIN	225
MARANTZ	050,096
MARTA	052
MATSUSHITA	050
MEI	050
MEMOREX	015,050,052,054,061,062,063,119,225
MESSENGER	058,076
MGN TECHNOLOGY	255
MINOLTA	057,120
MITSUBISHI	058,076,082,090,188,229,257
MOTOROLA	050,063

Maker	Set up codes
MTC	015,255
MULTITECH	015,087
NAD	073
NEC	053,055,056,065,082,097
NIKKO	052
NOBLEX	255
OLIMPUS	050,241
OPTIMUS	052,063,073,119
OPTONICA	077
PANASONIC	050,092,240,241
PENNEY	050,052,053,055,057,069,255
PENTAX	057,080,120
PHILCO	050
PHILIPS	050,077,096,125
PILOT	052
PIONEER	073,082
PORTLAND	035
PROTEC	087
PULSAR	054
QUARTER	061
QUARTZ	061
QUASAR	050,092
RADIO SHACK	015,052
RADIX	052
RANDEX	052
RCA	057,075,080,092,120,164,217
REALISTIC	015,050,052,061,062,063,077,081,119,255
RICOH	049
RUNCO	054
SAMSUNG	060,068,255
SANKY	054,063
SANSUI	056,082,097,286
SANYO	061,062,119,255
SCOTT	058,060,136,199,225,226,227
SEARS	050,052,057,061,062,069,081,119,120
SHARP	063,077
SHINTOM	087
SHOGUN	255
SINGER	087
SONY	047,048,049,050
STS	057
SYLVANIA	015,050,058,096,125
SYMPHONIC	015
TATUNG	056
TEAC	015,056
TECHNICS	050,177
TEKNIKA	015,050,052,067
TMK	223,255
TOSHIBA	058,060,081,225,227
TOTEVISION	052,255
UNITECH	255
VECTOR	060
VECTOR RESEARCH	053,055
VIDEO CONCEPTS	055,060,076
VIDEOSONIC	255
WARDS	015,050,057,062,063,077,087,164,227,255
XR-1000	015,050,087
YAMAHA	053
ZENITH	048,049,054

TV Set up codes

Maker	Set up codes
A-MARK	018
ABEX	047
ADMIRAL	108
ADVENTURA	061
AIKO	107
AKAI	045,113
ALARON	231
ALLERON	194,198
AMBASSADOR	192
ANAM	019,195
ANAM NATIONAL	070
AOC	018,034,045,067,152,200
ARCHER	018
AUDIOVOX	018,195
BELCOR	034
BELL & HOWELL	031,169
BRADFORD	195
BROCKWOOD	034
BROKSONIC	018
CANDLE	045,061,071,201
CARVER	069
CCE	232
CELEBRITY	015
CITIZEN	045,054,061,071,075,107,201,295
CLAIRTONE	200
CONCERTO	071
CONTEC	173,195,200
CRAIG	195
CROWN	054,195
CURTIS MATHES	045,054,075,169
CXC	195
DAEWOO	034,054,106,107,466
DAYTRON	034
DUMONT	032,034
DYNATECH	064
ELECTROBAND	015,200
EMERSON	034,053,054,169,173,192,193,194,195,196,197,198,200,251,285,295,297,478
ENVISION	045
FISHER	169,174
FUJITSU	194
FUNAI	194,195
FUTURETECH	195
GE	036,042,044,062,066,070,150,189,193,297
GIBRALTER	032,034,045
GOLDSTAR	016,017,034,045,047,054,071,121,193
GRUNPY	194,195
HALLMARK	193
HARVARD	195
HITACHI	047,053,071,110,112,160,166,188,242
IMA	195
INFINITY	069
JANEIL	061
JBL	069
JCB	015
JENSEN	065
JVC	051,068,197
KAMP	231
KAWASHO	173,231,323
KAYPANI	067
KENWOOD	034,045,171
KLOSS	039,061
KMC	121

Maker	Set up codes
KTV	045,054,195,198,200,232,295
LOGIK	031
LUXMAN	071
LXI	062,069,163,169,171,193
MAGNAVOX	045,051,069,111,201
MAJESTIC	031
MARANTZ	045,069
MATSUI	232
MEGATRON	018,160,093
MEI	200
MEMOREX	031,071,121,165,169,193
MGA	034,045,165,170,193
MIDLAND	032,047,054,062,066,150
MINUTZ	036
MITSUBISHI	034,113,165,170,193
MOTOROLA	070,108
MTC	034,045,064,071,075,106,200
MULTITECH	064,195,232
NAD	171,181,193
NEC	034,045,051,071,185
NIKKO	045,107,193,332
NTC	107
ONWA	195
OPTIMUS	169,181
OPTONICA	108,180
ORION	251
PANASONIC	066,069,070,177,265,353
PENNEY	017,018,033,034,036,042,045,047,054,062,066,075,125,150,164,171,193
PHILCO	034,045,069,111
PHILIPS	069
PILOT	034,045,054
PIONEER	053,181
PORTLAND	034,054,107
PRICECLUB	075
PRISM	066
PROSCAN	062
PROTON	018,046,067,193
PULSAR	032
PULSER	034
QUASAR	066,070,265
RADIO SHACK	034,047,054,180,195
RCA	033,034,044,053,062,105,150,189
REALISTIC	034,045,047,054,071,169,180,193,195
RHAPSODY	198,200,231
RUNCO	032,045
SAMPO	045,047,054,067,115,125
SAMSUNG	034,045,047,054,071,075,125,193
SAMSUX	054
SANYO	161,169,174
SCIMITSU	034
SCOTCH	193
SCOTT	034,193,194,195,251
SEARS	062,069,071,161,163,164,169,171,174,186,193,194
SHARP	054,108,180
SHOGUN	034
SIGNATURE	031
SIMPSON	201,202
SONY	015,026,095,126,288
SOUNDESIGN	193,194,195,201
SPECTRICON	018,152
SQUAREVIEW	186
SSS	034,195

TV Set up codes

Maker	Set up codes
STARLITE	195
SUPRE-MACY	061
SUPREME	015
SYLVANIA	045,069,080,111
SYMPHONIC	186
TANDY	108
TATUNG	018,064,070
TECHNICS	066,265
TECHWOOD	066,071
TEKNIKA	031,034,054,069,071,075,107,165,194,195,201,327,337
TERA	046
TMK	071,192193
TOSHIBA	051,075,164,169,171
TOSONIC	200
TOTEVISION	054
ULTRA	406
UNIVERSAL	042
VECTOR RESEARCH	045
VICTOR	068,265
VIDEO CONCEPTS	113
VIDEKRON	069
VIDTECH	034,193
VIKING	061
WARDS	031,034,035,036,042,043,044,045,069,071,095,111,126,180,189,193,194
YAMAHA	034,045
ZENITH	031,032
ZONDA	018

Cable Set up codes

Maker	Set up codes
ABC	016,018,022,023,026,028,029,032,062
ANTRONIX	222
ARCHER	054,168,222
CENTURY	168
CITIZEN	168
COLOUR VOICE	040,046
COMBAND	247,248
COMTRONICS	055,075
CONTEC	034
EASTERN	017
ELECTRICORD	093
FOCUS	415
GARRARD	168
GC ELECTRONICS	222
GE	247,248
GEMINI	030,072,085,257
GENERAL INSTRUMENT	026,291
GOLDSTAR	055159
HAMLIN	024,035,049,274,288
HITACHI	026
HITEX	022
JASCO	168
JERROLD	018,026,027,029,030,039,062,113,291
MACOM	048
MAGNAVOX	042
MEMOREX	015
MOVIE TIME	078,093,171
NORTHCOAST	329
NSC	078,085,171
OAK	022,034,263
PANASONIC	036,122

Maker	Set up codes
PARAGON	015
PHILIPS	040,042,043,044,045,046,168,257,305
PIONEER	038,159,275
POPULAR MECHANICS	415
PULSAR	015
RCA	036
REALISTIC	222
RECOTON	415
REGAL	035,274,288,294
REGENCY	017
REMBRANDT	026,085
RUNCO	015
SAMSUNG	055,159
SCIENTIFIC ATLANTA	021,023,032,292
SIGNAL	030,055
SIGNATURE	026
SL MARX	055
SPRUCER	036,322
STANDARD COMPONENTS	111
STARCOM	018,030,062,113
STARGATE	030,055
STARQUEST	030
SYLVANIA	016
TANDY	273
TATUNG	112
TEKNIKA	161
TELECAPTION	236
TELEVIEW	055
TEXSCAN	016,111
TOCOM	027,028,074
TOSHIBA	015
TUSA	030
TV86	078
UNIKA	168,222
UNITED ARTISTS	022
UNITED CABLE	018
UNIVERSAL	054,092,093,168,206,222,337
VIDEOWAY	265
VIDTECH	259
VIEWSTAR	042,075,078,226,273,304
ZENITH	015,069
ZENTEK	415

LD Set up codes

Maker	Set up codes
AIWA	218
CARVER	079
DENON	187
FUNAI	218
KENWOOD	273
MAGNAVOX	232,256
MARANTZ	079
MITSUBISHI	074
NAD	074
PANASONIC	219
PHILIPS	079
PIONEER	074
QUASAR	219
RCA	366
REALISTIC	218
SHARP	016
SONY	208,216
YAMAHA	232

Satellite Set up codes

Maker	Set up codes
BIRDVIEW	060
CHANNEL MASTER	033
CHAPARRAL	068
CITOH	179
DRAKE	033,079
ECHOSTAR	163,174,233,284,295,327
GENERAL INSTRUMENT	053,065
MACOM	033,065
MEMOREX	284
PROSAT	173
RCA	581
REALISTIC	067
STS	052
UNIDEN	067,089,091
ZENITH	079

Notes for using cable television or satellite broadcast reception equipment

Please note that the input selector and the components which can be used with this receiver vary according to the region in which it was purchased.

TV/CABLE: Lets you input signals from a TV or cable TV receiver and enter TV or cable TV set up codes.

TV/SAT: Lets you input signals from a TV or satellite receiver and enter TV or satellite receiver set up codes.

The specifications for each region are as follows.

Region	FM DE-EMPHASIS/CHANNEL SPACE switch position	Input selector name	Functional set up codes
For U.S.A., Canada and South American countries	_____	TV/CABLE	TV or Cable
For Australia	_____	TV/SAT.	TV or Satellite
For other countries (The specifications change according to the position of the FM DE-EMPHASIS/CHANNEL SPACE switch.)		TV/CABLE	TV or Cable
		TV/SAT.	TV or Satellite



Some set up codes cannot be used in certain regions.

The following chart shows all the menus that can be displayed in the OSD mode. Use this chart as a reference to determine the position of the current menu when using the GUI control mode. The numbers preceding the menu names correspond to the numbers in "Screen menu structure".

① MAIN MENU

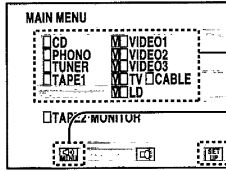

Switches to the operation menu for the respective component. — 40

Switches to the SOUND MENU.

Switches to the SET UP menu.

Set up menus

② SET UP

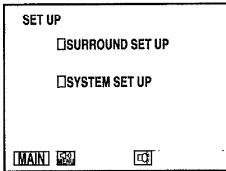

③ SPEAKER SELECTION&DISTANCE

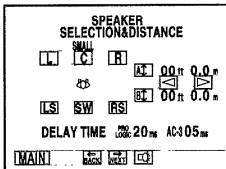

④ SPEAKER LEVEL

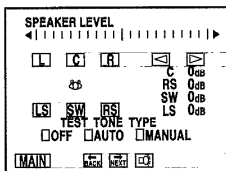

⑤ INPUT LEVEL

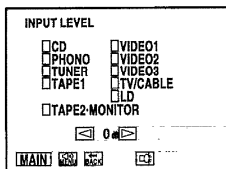

⑥ SYSTEM CONTROL

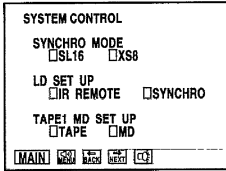

⑦ IR REMOTE CONTROL

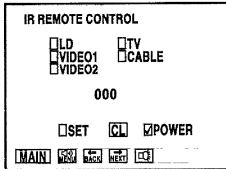

⑧ MACRO SET UP

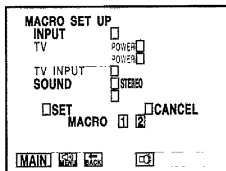

Sound menus

⑨ SOUND MENU

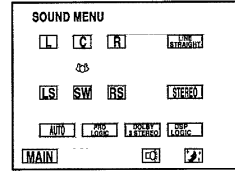

⑩ DSP CONTROL

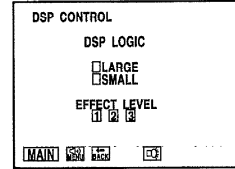

Operation menus

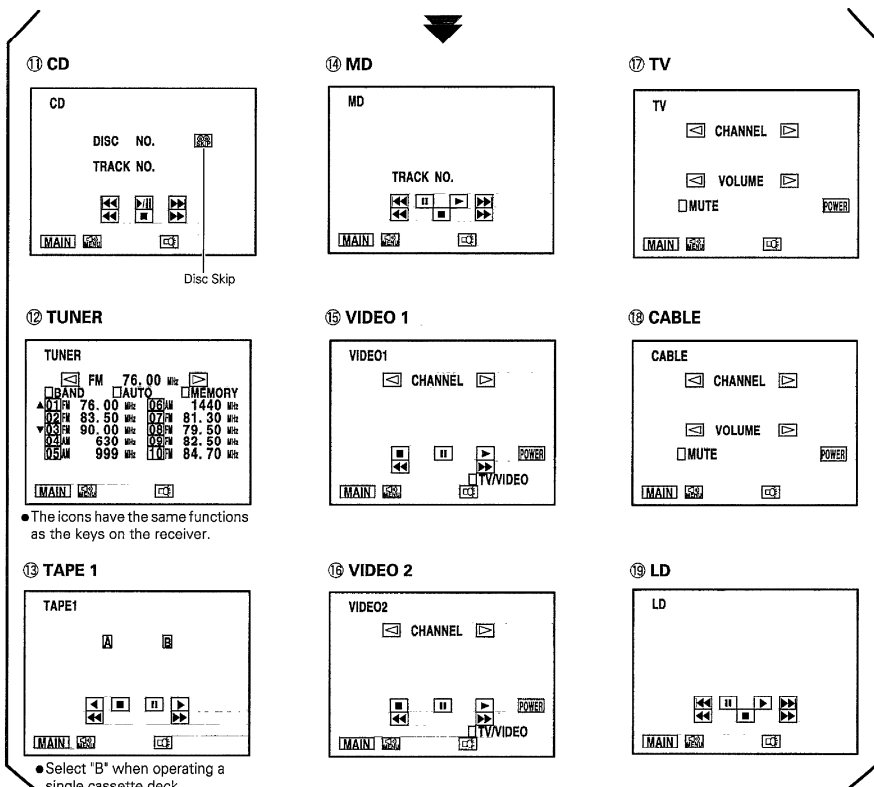

1. Refer to the operating instructions supplied with each component for details regarding their operation.
2. Selecting PHONO or VIDEO 3 from the main menu only switches the INPUT.
3. The operation screens are displayed in black and white when video signals are being input to the TV.
4. Some of the contents displayed may vary according to the operation mode.

Resetting the Microcomputer

If the microcomputer may malfunction (unit cannot be operated, or shows an erroneous display) if the power cord is unplugged while the power is ON, or due to some other external factor. If this happens, execute the following procedure to reset the microcomputer and return the unit to its normal operating condition.

With the power cord plugged in, turn the MAIN POWER key OFF. Then, while holding down the REMOTE POWER key, press MAIN POWER.

- Please note that resetting the microcomputer will clear the contents of the memory and returns the unit to the state it was in when it left the factory.





Amplifier

Symptom	Cause	Remedy
No sound from the speakers.	<ul style="list-style-type: none"> ● The speaker cords are disconnected. ● VOLUME is set to the minimum position. ● MUTE is ON. (The MUTE indicator is blinking) ● The SPEAKERS switches are set to OFF. ● The TAPE 2(MONITOR) key is set to ON. 	<ul style="list-style-type: none"> ● Connect them properly referring to "Connecting the speakers" - [10] ● Adjust the volume to a proper level. ● Turn OFF the MUTE. - [23] (use the remote) ● Set the SPEAKERS switch(es) to ON. - [22] ● Set the TAPE 2(MONITOR) key to OFF.
The standby indicator blinks and sound is not output.	<ul style="list-style-type: none"> ● Speaker cords are short-circuited. 	<ul style="list-style-type: none"> ● Turn the power off, eliminate the short-circuiting, then turn on the power again. - [10]
Sound is not output from one of the speakers.	<ul style="list-style-type: none"> ● The speaker cord is disconnected. ● The BALANCE control is set to an extreme position. 	<ul style="list-style-type: none"> ● Connect it properly referring to "Connecting the speakers". ● Adjust the Left/Right balance.
Sound is not output from the rear (surround) speakers and/or the center speaker, or their sound is very small.	<ul style="list-style-type: none"> ● The rear speaker cords and/or the center speaker cord is disconnected. ● A surround mode has not been engaged. ● The REAR VOL. and/or CENTER VOL. controls are set to the minimum level. 	<ul style="list-style-type: none"> ● Connect it properly referring to "Connecting the speakers". ● Select a surround mode. ● Adjust the REAR VOL. and CENTER VOL. controls.
Humming noise is generated when the PHONO input selector is selected.	<ul style="list-style-type: none"> ● The audio cord from the turntable is not connected to the PHONO jacks. ● The turntable is not grounded. 	<ul style="list-style-type: none"> ● Insert the audio cord plugs securely into the PHONO jacks. ● Connect the grounding wire to the GND terminal on the rear panel.

Tuner

Symptom	Cause	Remedy
Radio Stations cannot be received	<ul style="list-style-type: none"> ● No antenna is connected. ● The broadcast band is not set properly. ● The frequency of the desired station is not tuned. 	<ul style="list-style-type: none"> ● Connect an antenna. ● Set the broadcast band properly. ● Tune the frequency of the desired station. - [27]
Interference	<ul style="list-style-type: none"> ● Noise due to ignition noise from an automobile. ● Noise due to interference from an electric appliance. ● Noise due to a nearby TV set. 	<ul style="list-style-type: none"> ● Install the outdoor antenna away from the road. ● Turn off the power to the appliance. ● Install the receiver farther away from the TV.
A station which was preset cannot be received by pressing the corresponding numeric key.	<ul style="list-style-type: none"> ● The preset station belongs to a frequency that cannot be received. ● The preset memory was cleared because the power cord had been unplugged for a long period of time. 	<ul style="list-style-type: none"> ● Preset a station with a receivable frequency. ● Preset the station again.

Remote control unit

Symptom	Cause	Remedy
Remote control operation is not possible.	<ul style="list-style-type: none"> Batteries are exhausted. The remote control unit is too far away from the main system, controlling angle is too large, or there is an obstacle between the receiver and the remote. The audio cords and system control cords are not connected properly. No software is loaded in the source component. An attempt is made to play a tape which is being recorded in the cassette deck. The remote control has not been set to the operation mode for the component you wish to control. 	<ul style="list-style-type: none"> Replace with new batteries.  Operate the remote control unit within the controllable range. Connect properly referring to "System connections".  Place software in the source component you want to play. Wait until recording has completed. Press the component control selection key corresponding to the component you wish to control to activate the respective control mode before operation.  



Do not use contact cleaning agents because they could cause a malfunction. Be specifically careful against using contact cleaning agents containing oil, since they may deform the plastic components.

For the U.S.A.

FCC WARNING

This equipment may generate or use radio frequency energy. Changes or modifications to this equipment may cause harmful interference unless the modifications are expressly approved in the instruction manual. The user could lose the authority to operate this equipment if an unauthorized change or modification is made.

NOTE:

This equipment has been tested and found to comply with the limits for a Class B digital device, pursuant to Part 15 of the FCC Rules. These limits are designed to provide reasonable protection against harmful interference in a residential installation. This equipment may cause harmful interference to radio communications, if it is not installed and used in accordance with the instructions. However, there is no guarantee that interference will not occur in a particular installation. If this equipment does cause harmful interference to radio or television reception, which can be determined by turning the equipment off and on, the user is encouraged to try to correct the interference by one or more of the following measures:

- Reorient or relocate the receiving antenna.
- Increase the separation between the equipment and receiver.
- Connect the equipment into an outlet on a circuit different from that to which the receiver is connected.
- Consult the dealer or an experienced radio / TV technician for help.

For the U.S.A.

Note to CATV system installer:

This reminder is provided to call the CATV system installer's attention to Article 820-40 of the NEC that provides guidelines for proper grounding and, in particular, specifies that the cable ground shall be connected to the grounding system of the building, as close to the point of cable entry as practical.

Memory back up function

Please note that the following items will be deleted from the receiver's memory if the receiver is not turned on for a period of approximately 3 days.

- Power mode.
- SYSTEM CONTROL MODE setting.
- Settings made using OSD (like SYSTEM SET UP and SURROUND SET UP).
- Input selector settings (including MD and LD).
- Volume level.
- Broadcast band.
- Frequency setting.
- Preset stations.

Specifications (For U.S.A. and Canada)

KR-V990D (En)

Rated power output during STEREO operation

120 watts per channel minimum RMS, both channels driven, at 8 Ω from 20 Hz to 20 kHz with no more than 0.03 % total harmonic distortion.(FTC)

Rated power output during SURROUND operation

Front

105 watts per channel minimum RMS, both channels driven, at 8 Ω, 1kHz with no more than 0.7 % total harmonic distortion.

Center

105 minimum RMS at 8 Ω, 1kHz with no more than 0.7 % total harmonic distortion.

Rear

70 watts per channel minimum RMS, both channels driven, at 8 Ω, 1kHz with no more than 0.7 % total harmonic distortion.

Total harmonic distortion 0.005%(1 kHz, 60W, 8 Ω)

Frequency response

LINE(CD, AUX, TAPE) 10 Hz ~ 75 kHz, + 0 dB, -3 dB

Signal to noise ratio (IHF'66)

PHONO(MM) 75 dB

LINE(CD, AUX, TAPE) 98 dB

Input sensitivity / impedance

PHONO (MM) 2.5 mV / 47 kΩ

LINE(CD, AUX, TAPE) 200 mV / 47 kΩ

Output level / impedance

TAPE REC 200 mV / 2.2 kΩ

PRE OUT (FRONT, CENTER, REAR, SUBWOOFER)

..... 1 V / 1 kΩ

Tone Control

BASS ±10 dB (at 100 Hz)

TREBLE ±10 dB (at 10 kHz)

LOUDNESS control

VOLUME at -30 dB level +8 dB (at 100 Hz)

DIGITAL AUDIO section

Sampling frequency 32 kHz, 44.1 kHz, 48 kHz

Input level / impedance

Coaxial (TV/CABLE) 0.5 Vp-p / 75 Ω

VIDEO section

TELEVISION format NTSC

VIDEO inputs / outputs

VIDEO (composite) 1 Vp-p / 75 Ω

S-VIDEO (luminance signal) 1 Vp-p / 75 Ω

(chrominance signal) 0.286 Vp-p / 75 Ω

FM tuner section

Tuning frequency range 87.5 MHz ~ 108 MHz

Usable sensitivity (MONO)

..... 1.2μV (75 Ω)/ 13.2 dBf (75 kHz DEV., S/N 30 dB)

50dB quieting sensitivity

STEREO 32μV (75 Ω)/ 41.2 dBf (75 kHz DEV.)

Total harmonic distortion (1 kHz)

MONO 0.6 % (65.2 dBf input)

STEREO 0.7 % (65.2 dBf input)

Signal to noise ratio (1 kHz, 75 kHz DEV.)

MONO 75 dB (65.2 dBf input)

STEREO 68 dB (65.2 dBf input)

Selectivity (±400 kHz) 50 dB

Stereo separation (1 kHz) 40 dB

Frequency response 30 Hz ~ 15kHz,+0.5 dB, -3.0 dB

AM tuner section

Tuning frequency range 530 kHz ~ 1.700 kHz

Usable sensitivity (30% mod., S/N 20 dB)

..... 16 μV / (500 μV/m)

Total harmonic distortion 0.7 %

Signal to noise ratio (30 % mod. 1 mV input) 45 dB

Selectivity 30 dB

GENERAL

Power consumption 5.2 A

AC outlet

SWITCHED 2 (total 150 W, 1.2 A max.)

Dimensions W : 440 mm (17 - 5/16")

..... H : 162 mm (6 - 3/8")

..... D : 396 mm (15 - 9/16")

Weight (Net) 13.1 kg (28.9 lb)



Specifications (For other countries)

⚠ Caution : Read this page carefully to ensure safe operation.

KR-V990D (En)

AUDIO section

Rated power output during STEREO operation	
(EIAJ) 1kHz, 10% T.H.D. at 8 Ω	150 W + 150 W
(DIN/IEC) at 8 Ω	120 W + 120 W
Rated power output during SURROUND operation	
FRONT(1kHz, 10% T.H.D. at 8 Ω)	150 W + 150 W
CENTER (1kHz, 10% T.H.D. at 8 Ω)	150 W
REAR(1kHz, 10% T.H.D. at 8 Ω)	65 W + 65 W
Total harmonic distortion	0.005 % (1kHz, 60 W, 8 Ω)
Frequency response	
LINE (CD, AUX, TAPE)	10 Hz ~ 75 kHz, +0 dB, -3 dB
Signal to noise ratio (IHF'66)	
PHONO (MM)	75 dB
LINE (CD, AUX, TAPE)	98 dB
Input sensitivity / impedance	
PHONO (MM)	2.5 mV / 47 kΩ
LINE (CD, AUX, TAPE)	200 mV / 47 kΩ
Output level / impedance	
TAPE REC	200 mV / 2.2 kΩ
PRE OUT (FRONT, CENTER, REAR, SUBWOOFER)	1 V / 1 kΩ
Tone control	
BASS	±10 dB (at 100 Hz)
TREBLE	±10 dB (at 10 kHz)
LOUDNESS control	
VOLUME at -30dB level	+8 dB (100 Hz)

DIGITAL AUDIO section

Sampling frequency	32 kHz, 44.1 kHz, 48 kHz
Input level / impedance	
Coaxial (TV/CABLE)	0.5 V _{p-p} / 75 Ω

VIDEO section

TELEVISION format	NTSC
VIDEO inputs / outputs	
VIDEO (composite)	1 V _{p-p} / 75 Ω
S-VIDEO (luminance signal)	1 V _{p-p} / 75 Ω
(chrominance signal)	0.286 V _{p-p} / 75 Ω

FM tuner section

Tuning frequency range	87.5 MHz ~ 108 MHz
Usable sensitivity (MONO)	
	1.2μV (75 Ω) / 13.2 dBf (75 kHz DEV., S/N 30 dB)
50dB quieting sensitivity	
STEREO	32μV (75 Ω) / 41.2 dBf (75 kHz DEV.)
Total harmonic distortion (1 kHz)	
MONO	0.6 % (65.2 dBf input)
STEREO	0.7 % (65.2 dBf input)
Signal to noise ratio (1 kHz, 75 kHz DEV.)	
MONO	75 dB (65.2 dBf input)
STEREO	68 dB (65.2 dBf input)
Selectivity (±400 kHz)	50 dB
Stereo separation (1 kHz)	40 dB
Frequency response	30 Hz ~ 15kHz, +0.5 dB, -3.0 dB

AM tuner section

Tuning frequency range	
9 kHz step	530 kHz ~ 1.602 kHz
10 kHz step	530 kHz ~ 1.610 kHz
Usable sensitivity (30% mod., S/N 20 dB)	
	16 μV / (500 μV/m)
Total harmonic distortion	0.7 %
Signal to noise ratio (30 % mod. 1 mV input)	45 dB
Selectivity	30 dB

GENERAL

Power consumption	450 W
AC outlet	
SWITCHED (for Australia)	1 (total 90 W max.)
SWITCHED (for other countries)	2 (total 90 W max.)
Dimensions	W : 440 mm
	H : 162 mm
	D : 396 mm
Weight (Net)	13.1 kg



KENWOOD follows a policy of continuous advancements in development. For this reason specifications may be changed without notice.

KENWOOD

For your records

Record the serial number, found on the back of the unit, in the spaces designated on the warranty card, and in the space provided below. Refer to the model and serial numbers whenever you call upon your dealer for information or service on this product.

Model _____ Serial Number _____